

Flex I/O Series

I/O Expansion Module for MIC-7 Series

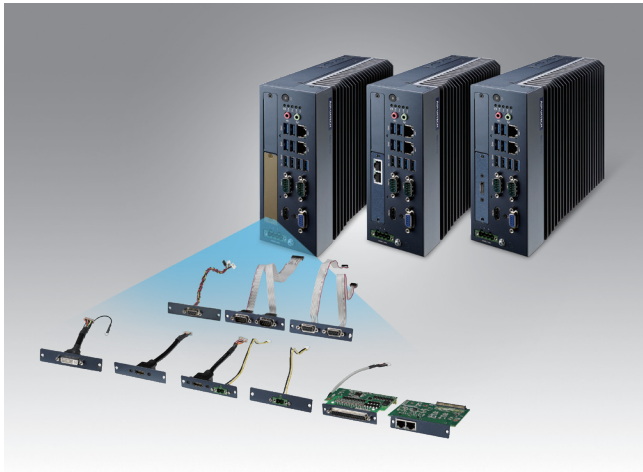

Features

- Flexible expansion for various I/O connection
- Flex I/O expansion on the front panel for same-side cabling
- Support various display interfaces and the 3rd output
- Support I/O and intelligent alarm function
- Expand two more LAN ports
- Expand for 2 x 2.5" SSD
- Support TPM module
- MIC-7 Series compatible

Introduction

Flex I/O series modules provide flexible expansion for MIC-7 Series so customers can enjoy display, more control, and better communication via Flex I/O. All Flex I/O are attached directly from connectors reserved on the MIC-7 series main board and installed on the front panel, making it easy to fulfill machine, factory automation, and IEM deployments.

Flex I/O Assembly Example

Small Flex I/O



Default MIC-770



Small Flex I/O Remote Switch



After Assembly

Regular Flex I/O



Default MIC-770



Regular Flex I/O DVI



After Assembly



Default MIC-770



Small Flex I/O Remote Switch



Regular Flex I/O DVI



After Assembly

Advanced Flex I/O



Default MIC-770



Advanced Flex I/O NVME + 4x LAN



After Assembly



Default MIC-770























Advanced Flex I/O 4 x PoE



After Assembly

Flex I/O Series

Compatible Table

Flex I/O	Function	Part Number	MIC-7500	MIC-7700		MIC-770 V1		MIC-770 V2		MIC-770 V3		MIC-7900
				MIC-7700Q	MIC-7700H	MIC-770Q	MIC-770H	MIC-770W	MIC-770H	MIC-770W	MIC-770H	
Small FIO												
	Remote Switch	98R17500701	-	-	-	✓	✓	✓	✓	✓	✓	-
	GPIO module (32bit)	AIS-DIO32-00A1E	✓	✓	✓	✓	✓	✓	✓	✓	✓	✓
Regular FIO												
	DVI	98R17500001	✓	✓	✓	✓	✓	✓	✓	✓	✓	-
	HDMI & Remote Switch	98R17500101	✓	✓	✓	✓	✓	✓	✓	✓	✓	-
	HDMI	98R17500301	✓	✓	✓	✓	✓	✓	✓	✓	✓	-
	Remote Switch	98R17500401	✓	✓	✓	✓	✓	✓	✓	✓	✓	✓
	4x COM RS-232	98R17500601	-	-	-	✓	✓	✓	✓	✓	✓	-
	Reset & Remote Switch & 5VDC	98R17500801	✓	✓	✓	✓	✓	✓	✓	-	-	✓
	Reset & Remote Switch & 5VDC (SATA)	98R17500802	-	-	-	-	-	-	-	✓	✓	-
	16 bit GPIO	98R17500901	8 bit	✓	✓	✓	✓	✓	✓	✓	✓	8 bit
	Display Port	98R17501001	-	✓	✓	-	-	✓	✓	✓	✓	-
	Dual LAN	9891790040E	-	✓	-	-	-	-	-	-	-	-
	TPM 2.0 module (LPC)	PCA-TPM-00B1E	✓	✓	✓	✓	✓	✓	✓	-	-	-
	TPM 2.0 module (SPI)	PCA-TPMSPI-00A1	-	-	-	-	-	-	-	✓	✓	-
	2x SSD kit	98R1752020E	-	✓	-	✓	✓	✓	✓	✓	✓	✓
Advanced FIO*												
	2 x Lan, i210AT	98910770320	-	-	-	✓	-	✓	-	✓	-	-
	NVME +4 x Lan, i210AT	98910770330	-	-	-	✓	-	✓	-	✓	-	-
	2 x Lan, i226V	98910770340	-	-	-	✓	-	✓	-	✓	-	-
	NVME +4 x Lan, i226V	98910770350	-	-	-	✓	-	✓	-	✓	-	-
	NVME	98910770401	-	-	-	✓	-	✓	-	✓	-	-
	4 x PoE	98910770501	-	-	-	✓	-	✓	-	✓	-	-

* H SKU does not support. Please refer to Advanced Flex I/O datasheet for more detail.
 Note: For the additional display port (DVI/HDMI/DP), please refer to the MIC-7 series datasheet.

Ordering Information

Part Number	Description
98R17500001	MIC DVI kit FIO
98R17500101	MIC HDMI/Remote Switch kit FIO
98R17500301	MIC HDMI kit FIO
98R17500401	MIC Remote Switch kit FIO
98R17500601	MIC COMport kit FIO (4x COM RS-232 via 2x dual DB9 cable)
98R17500701	MIC Remote Switch kit for SFIO
98R17500801	MIC Reset/Remote Switch/5VDC kit FIO
98R17500802	MIC Reset/Remote power on/off/5VDC kit FIO (SATA)
98R17500901	MIC GPIO kit (2x 8 bit GPIO cables)
98R17501001	MIC Display Port kit FIO
9891790040E*	MIC Dual LAN kit FIO
AIIS-DIO32-00A1E**	AIIS GPIO (32 bit)
PCA-TPM-00B1E	TPM 2.0 module (LPC)
PCA-TPMSPI-00A1	TPM 2.0 module (SPI)
98R1752020E	2 x 2.5" SSD kit (7mm thick)
Advanced Flex I/O	
98910770320	MIC 2 x Lan, i210AT
98910770330	MIC NVMe +4 x Lan, i210AT
98910770340	MIC 2 x Lan, i226V
98910770350	MIC NVMe +4 x Lan, i226V
98910770401	MIC NVMe FIO
98910770501***	MIC 4 PoE FIO

Note: Cable/module, cover and screws are included.

*Can't support PCA-TPM-00B1E when install 9891790040E.

** Can only be placed in the small FIO location and can't be installed with other flex IO.

*** Can't be installed with other flex IO.

Pin Definition

98R17500101, 98R17500401, 98R17500701

Remote switch pin definition

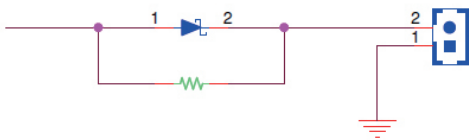

Connector pin definition

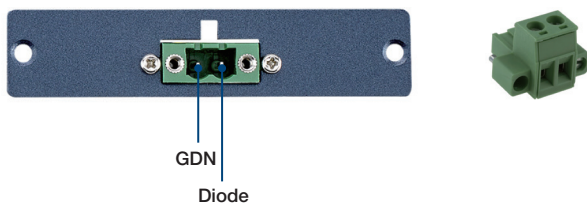

Note: 2-pin phoenix contact terminal block is included in remote switch kit. Can connect to ATX power button via cable. Remote switch supports ATX power button via 2-pin (power button is not included).

98R1752020E 2x 2.5" SSD kit Assembly

2 x 2.5" SSD assembled in the dual SSD tray

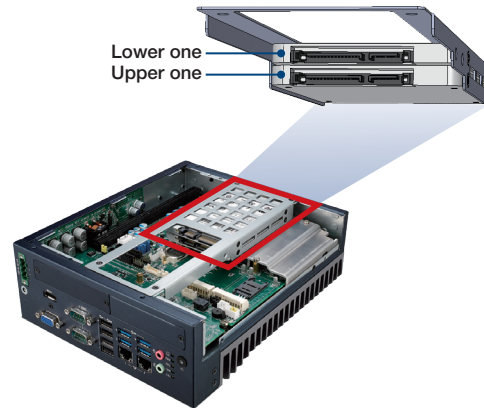

Example: Assembled inside of MIC-770

Note 1: Compatible with MIC-7 series Flex I/O and Advanced Flex I/O

Note 2: Support 2 x 2.5" 7mm thick SSD only (HDD is not recommended)

Note 3: SSD is not included

98R17500601

COM 34/56 pin definition

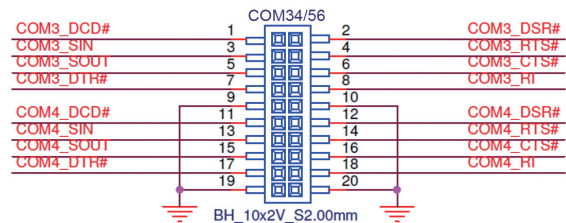

DB9 Connector pin definition

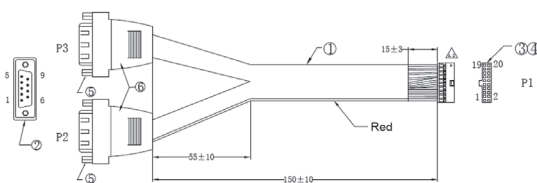

PIN OUT

P1	WIRE	COLOR	P2	P3
1			1	
2			6	
3			2	
4			7	
5			3	
6			8	
7			4	
8			9	
9			5	
10				
11			1	
12			6	
13			2	
14			7	
15			3	
16			8	
17			4	
18			9	
19			5	
20			S	

98R17500801

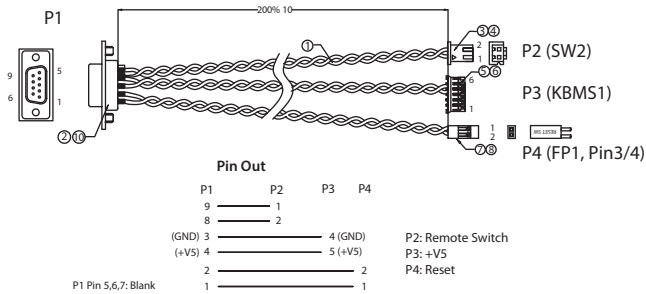

AIIS-DIO32-00A1E

DIO pin definition

Pin01 => IDI0	Pin20 => IDI1
Pin02 => IDI2	Pin21 => IDI3
Pin03 => IDI4	Pin22 => IDI5
Pin04 => IDI6	Pin23 => IDI7
Pin05 => IDI8	Pin24 => IDI9
Pin06 => IDI10	Pin25 => IDI11
Pin07 => IDI12	Pin26 => IDI13
Pin08 => IDI14	Pin27 => IDI15
Pin09 => [GND]	Pin28 => [GND]
Pin10 => PCOM1	Pin29 => [GND]
Pin11 => IDO0	Pin30 => IDO1
Pin12 => IDO2	Pin31 => IDO3
Pin13 => IDO4	Pin32 => IDO5
Pin14 => IDO6	Pin33 => IDO7
Pin15 => IDO8	Pin34 => IDO9
Pin16 => IDO10	Pin35 => IDO11
Pin17 => IDO12	Pin36 => IDO13
Pin18 => IDO14	Pin37 => IDO15
Pin19 => PCOM2	

98R17500802

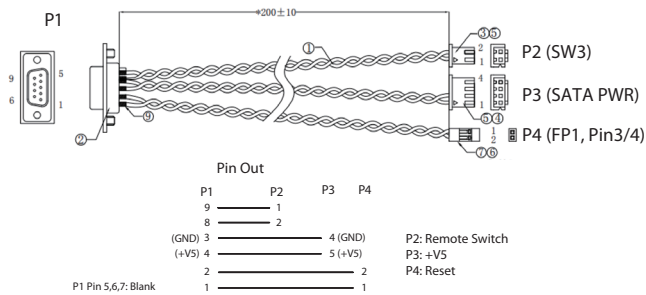

DB37 connector pin definition

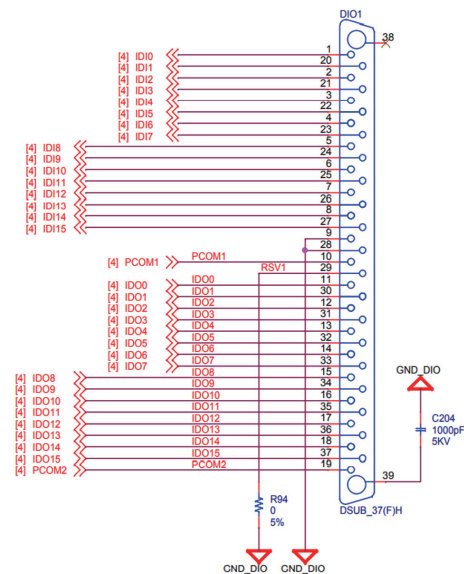

98R17500901

GPIO 0/1 pin definition

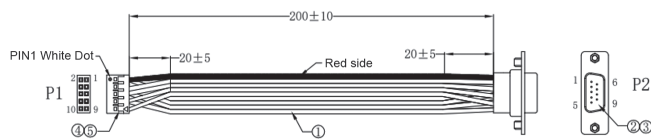
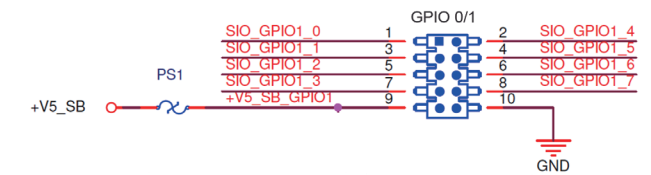

PIN OUT

P1	Red	P2
1		1
3		2
5		3
7		4
10		5
2		6
4		7
6		8
8		9

Note 1: GPIO0 and GPIO1 pin definition are the same.
Note 2: P1 Pin 9: Blank