

# MIC-75G30

## Dual GPU Expansion Module for Video AI Edge Computing with MIC-7 Series



### Features

- Offering powerful GPU solution with dual NVIDIA 350W, 3/2.5-slot width/322mm length GPU cards for new AI application
- Triple 24VDC power inputs, provide independent power for GPU cards and MIC-7 system
- Intelligent power status indicating LED for system and GPU card independently
- Ruggedized design to sustain dual GPU cards with 1 Grms Op. vibration validation
- Dual front removable 2.5" storage bay for easy swap
- Support up to 35°C operating temperature
- IP30 rating with fan filter, suitable for outdoor or industrial environment
- Compact size design

### Introduction

MIC-75G30 supports up to dual NVIDIA high performance 350W fan-based cards. Robust power design ensures MIC-7 systems and GPU card's reliability under high power consumption application. Suitable for Video AI Edge computing, 3D image processing and vision application.

### Specification

Expansion slot	<b>Slot 1:</b> Blank <b>Slot 2:</b> Blank <b>Slot 3:</b> PCIe x16 (signal PCIe x8) for GPU card <b>Slot 4:</b> Blank <b>Slot 5:</b> Blank <b>Slot 6:</b> PCIe x16 (signal PCIe x8) for GPU card <b>Slot 7:</b> PCIe x4
SATA Connector	1 x SATA Signal, 1 x SATA Power
Storage	2 x 2.5" swappable HDD/SSD storage bay
Power	Input: Triple 24 V <sub>DC</sub> (one on MIC-770 system, two on MIC-75G30 for dual 350W GPU cards) Power consumption: Typical: 1000W (Tested with dual 350W GPU card with MIC-770V3W, 35W CPU and 4-port PoE cards) Power solution supports up to maximum 1,200W (Tested with dual 350W GPU card's peak power consumption) 4 x 6-pin Conn. for GPU card (12V <sub>DC</sub> , 17A for each Conn.) 1 x 4-pin Conn. for add-on card (12V <sub>DC</sub> , 5A)
GPU Card Dimension	Thickness: 60 mm (3-slot) / 50 mm (2-slot), Length: 322 mm, Height: 120 mm Support up to triple-fan GPU cards
LED	Indicator LED for power status
Environment	Operating Temp.: 0~35 °C (35W CPU w/ industrial SSD), with 0.7m/sec air flow Vibration: With SSD: 1 Grms @ 5~500 Hz, random, 1 hr/axis Shock: With SSD: 10G, IEC-68-2-27, half-sine wave, 11 ms duration
Mechanical	MIC-75G30 N.W. 5 kg; G.W.: 7 kg Dimension (W x H x D): 280 x 192 x 385 mm
Fan	1x 12038 cooling fan embedded (8300 RPM, 238 CFM, Max. 79.3 dB)

### Front View

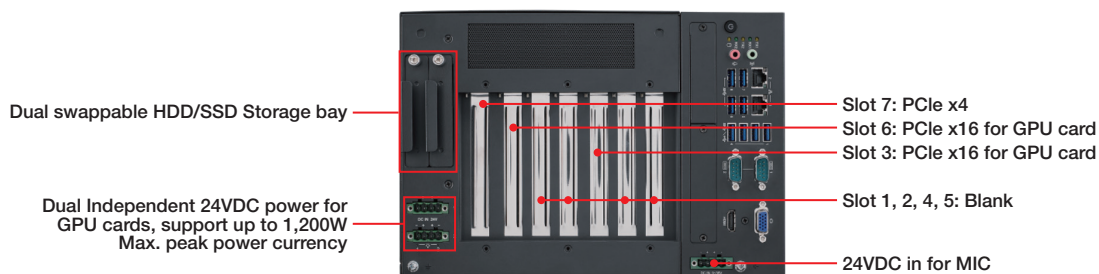

## Mounting Type and Dimensions

**Example: MIC-770 + MIC-75G30**

W x H x D: 280 x 192 x 385 mm

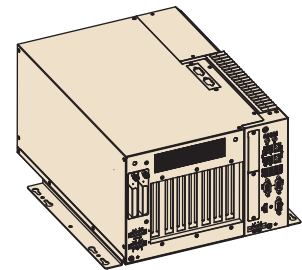
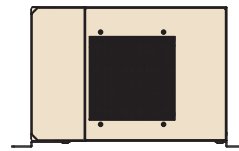
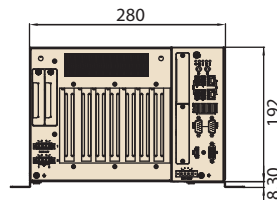
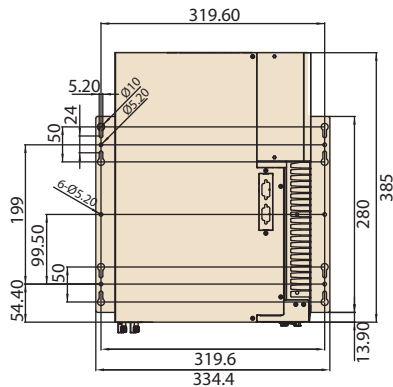

**Note:**  
Suggest to reserve at least 25mm space from the rear side for fan air flow.

## GPU Card Dimension Guide

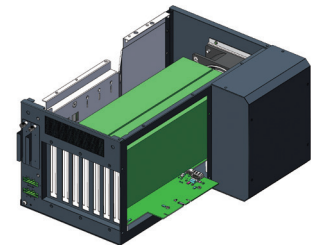
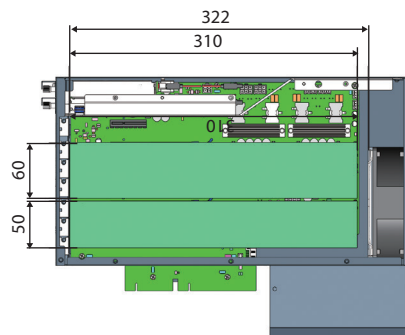
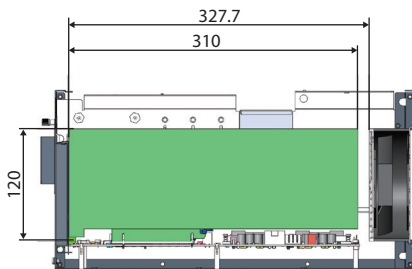

## Ordering Information

Part Number	Description
MIC-75G30-00C1*	Dual GPU expansion i-Module with 2x PCIe x16 slots (signal PCIe x8), 1x PCIe x4, dual 2.5" swappable storage bay

\* MIC-7 series H SKU does not support MIC-75G30. Please refer to i-Module datasheet for compatibility matrix.

## Packing List

Part Number	Description	Quantity
1652003234	4-pin phoenix connector	2
1700003194	SATA cable (60cm)	2
1700024985-01	HDD BP power cable	1
1700034485-01	GPU power cable (6 to 6/8 Pin)	4
1960094390N000	GPU bracket	2
1930005673-11	Screw for GPU bracket	10
1990000505T000	Shock proof rubber	5
1960005359T00A	Mounting bracket (L)	1
1960094392N013	Mounting bracket (R)	1
1930007259-01	Screw for mounting bracket	6
2041563003	MIC-75G30 Start-up manual	1

## Optional Accessories

Part Number	Description
XMIC-HRPG-1000-24*	100-240V, 1008W, 24V PSU
1700031413-01	PSU DC-DC power cable, 1M
1700029720-01	PSU power cord (USA), AC Conn., 3-pin, 10A, 125V, UL/CSA, 1.83M
1700030520-01	PSU power cord (CN), AC Conn., 3-pin, 10A, 250V, CCC, 1.5M
1700031408-01	M cable conn 3P/G-TEM*3 80CM (EU)
1700022074-11	4-pin 12V <sub>DC</sub> power cable (40cm, for PoE card)

\* Recommend to use for powering MIC-75G30 + MIC-7000.

## Power Supply Cabling Guide



AC-DC PSU power cord (1.83M)  
 P/N: 1700029720-01 (USA)  
 1700030520-01 (CN)  
 1700031408-01 (EU))

DC-DC PSU power cord: 1700031413-01

## PSU pin-out and dimension (unit: mm)

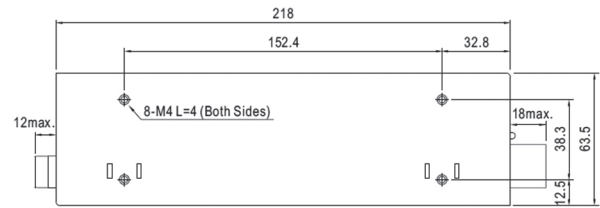
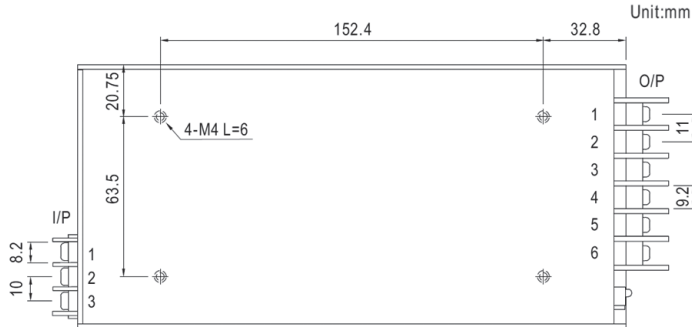

AC Input Terminal Pin No. Assignment

Pin No.	Assignment
1	AC/L
2	AC/N
3	FG $\perp$

DC Output Terminal Pin No. Assignment

Pin No.	Assignment
1~3	+V
4~6	-V

### PSU power cord & Pin Definition (connect from AC to DC)

