

USERS GUIDE

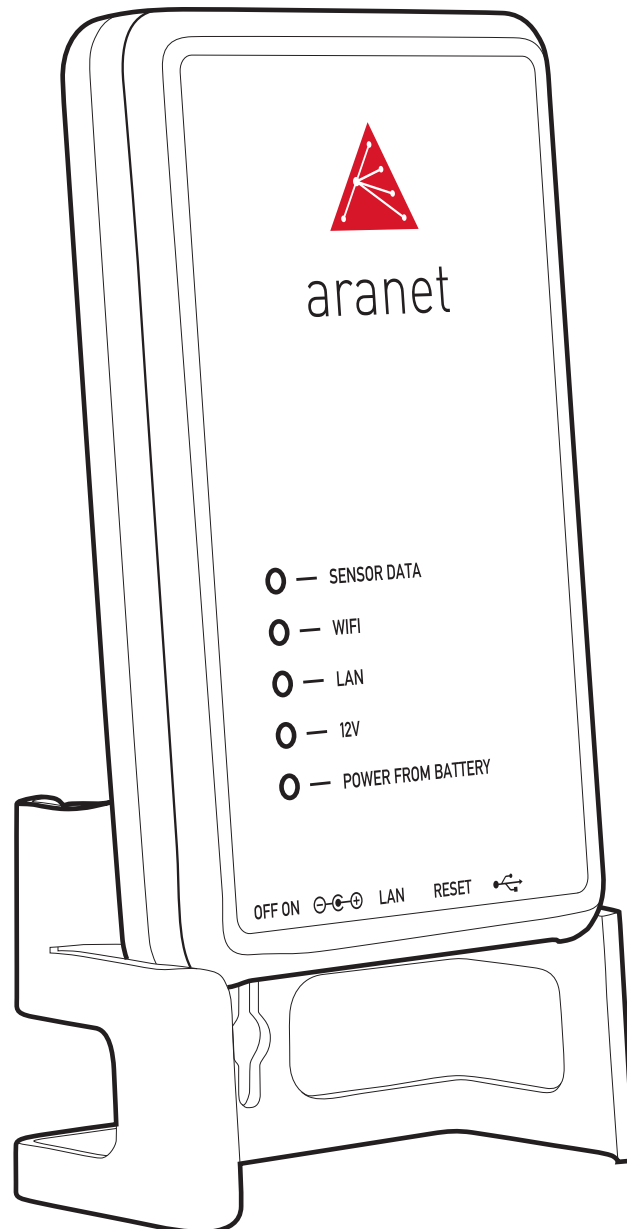

aranet



Aranet PRO User's Guide

Applicable for Aranet PRO 12, Aranet PRO 50, Aranet PRO 100

Version No.2

TABLE OF CONTENTS

| | |
|---|----|
| Introduction..... | 1 |
| Aranet PRO base station overview..... | 2 |
| What's in the box..... | 2 |
| Aranet PRO..... | 3 |
| Aranet PRO ports..... | 4 |
| Aranet PRO Datasheet..... | 4 |
| Configuration..... | 6 |
| Router configuration WiFi..... | 6 |
| How to: Initial setup of Aranet PRO via WiFi..... | 6 |
| How to: Initial setup of Aranet PRO via router..... | 6 |
| How to: Initial setup of Aranet PRO connected to a Windows PC via Ethernet cable..... | 6 |
| How to: Initial Login..... | 7 |
| Recommended network configuration..... | 7 |
| Sensor pairing in Aranet SensorHUB..... | 8 |
| How to: Pair sensors to Aranet PRO..... | 8 |
| Sensor grouping in Aranet SensorHUB..... | 10 |
| How to: Using groups..... | 10 |
| Aranet SensorHUB overview..... | 12 |
| Main navigation bar..... | 12 |
| Main menu..... | 12 |
| Graphs..... | 14 |
| Notifications..... | 15 |
| SMS screen..... | 17 |
| E-mail screen..... | 17 |
| Region..... | 18 |
| Sensor..... | 18 |
| Radio menu..... | 18 |

| | |
|--|----|
| System..... | 19 |
| Time menu..... | 20 |
| Backup menu..... | 21 |
| Firmware menu..... | 21 |
| Aranet MINI monitor mode – Aranet LITE..... | 22 |
| Network..... | 23 |
| WiFi menu..... | 23 |
| Ethernet menu..... | 24 |
| Users..... | 25 |
| Terms of use..... | 26 |
| Warranty..... | 26 |
| RMA (Return Merchandise Authorization) form..... | 29 |
| Intellectual Property Rights..... | 29 |
| Data Security..... | 30 |
| Cleaning And Maintenance | 30 |
| Accessories..... | 31 |
| Disclaimer..... | 31 |
| Additional information..... | 31 |

INTRODUCTION

Aranet offers environmental monitoring solutions for a variety of businesses. Aranet PRO is an industrial grade environment monitoring solution.

Aranet PRO comes in three variations - Aranet PRO 12, Aranet PRO 50 and Aranet PRO 100.

- Aranet PRO 100 permits connecting up to 100 sensors,
- Aranet PRO 50 allows 50 sensors, and
- Aranet PRO 12 grants 12 sensor connectivity per base station.

The base station has exceptional sensitivity of -133dBm and allows placing the sensors within line - of - sight range of at least 3km/1.9mi.

All Aranet PRO base stations include embedded local web-server Aranet SensorHUB. Easy to use interface allows viewing, analysing and comparing data in real time, setting thresholds for alarms as well as exporting reports. Responsive design of the software adapts to smartphone, tablet or laptop.

Visit www.aranet.com for more information.

ARANET PRO BASE STATION OVERVIEW

What's in the box



- (1) Aranet PRO base station + Aranet SensorHUB software
- (2) Aranet PRO base station mount with 2 W1412 screws
- (3) AC power adapter

Aranet PRO

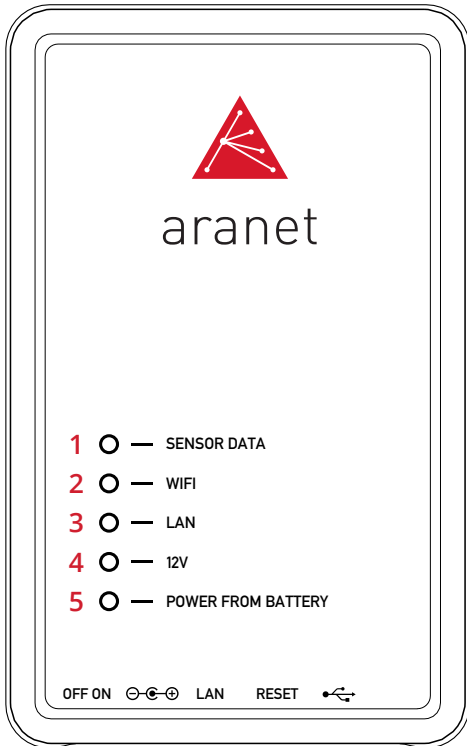

- (1) Sensor data indicator LED – flashes amber every time a data packet is received from a sensor.
- (2) WiFi connection indicator LED – amber light when Aranet PRO is connected to WiFi or works in Access Point mode
- (3) LAN connection indicator LED – amber light when Aranet PRO is connected to LAN connection through an Ethernet cable
- (4) 12V power indicator LED – green light when Aranet PRO is connected to 12V power either through a PoE connection or with the included AC power adapter
- (5) Battery power indicator LED – red light when Aranet PRO is using built in back up battery power

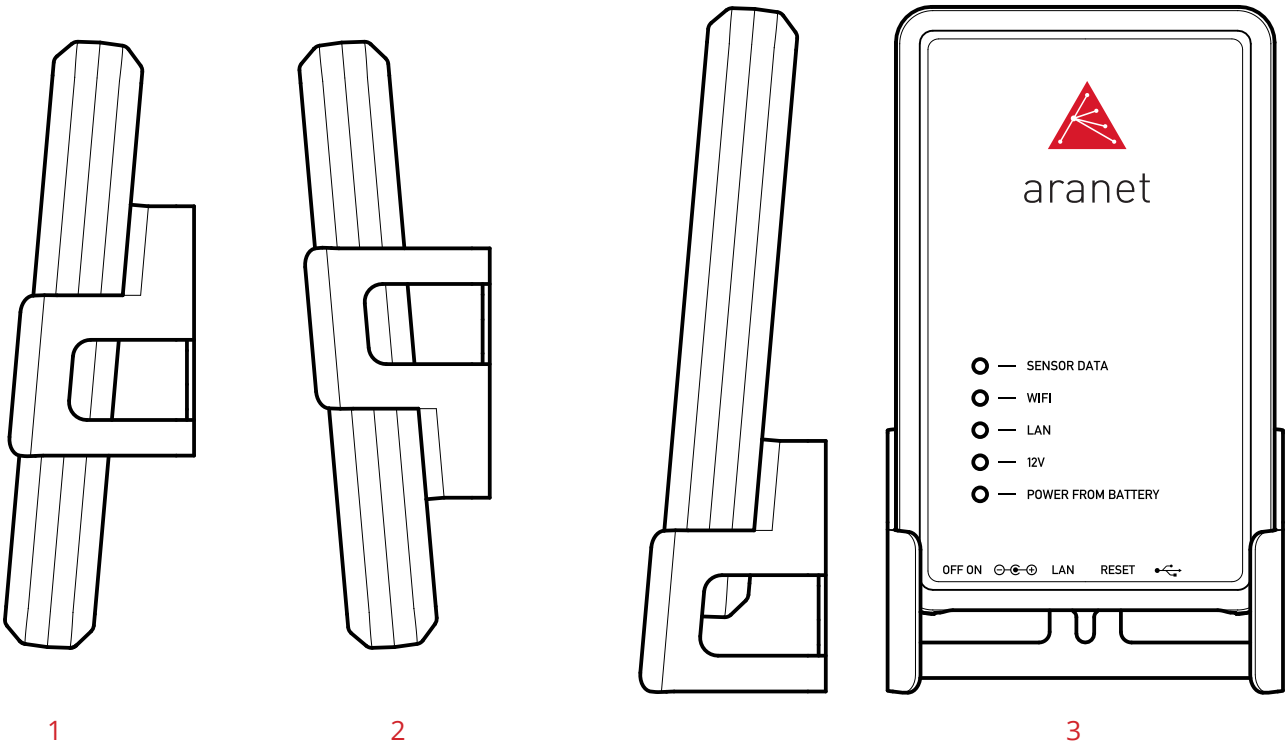

- (1) Base station mount configuration for positioning on vertical surface (e.g. wall).
- (2) Base station mount configuration for positioning on vertical surface (e.g. wall).
- (3) Base station mount configuration for placement on horizontal surface (e.g. table).

Aranet PRO ports

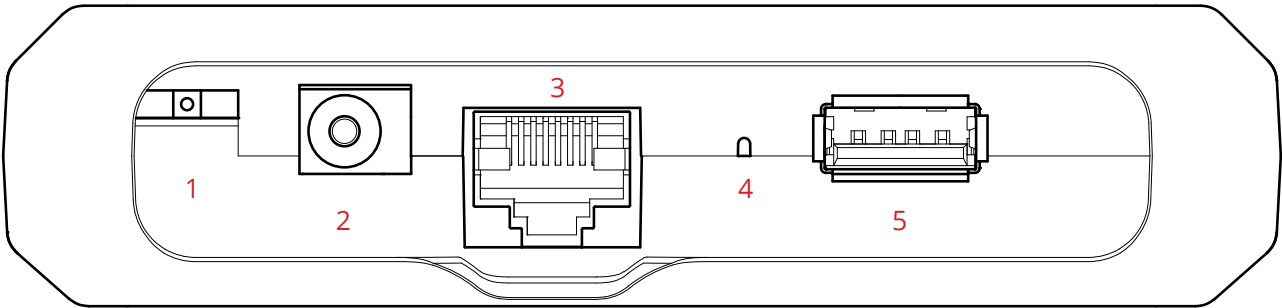

- (1) On-Off switch – switch in the left position means Aranet PRO is turned off, switch in the right position means Aranet PRO is turned on
- (2) AC Power port - for using the included AC power adapter to power Aranet PRO
- (3) Ethernet port – for LAN connectivity as well as PoE connectivity
- (4) Network reset button, press and hold for 5 seconds or more to reset network settings and password of “root” user account
- (5) USB port – for connecting USB GSM modem to enable SMS notification functionality

Aranet PRO Datasheet

| Aranet PRO | |
|-------------------------|---|
| Maximum sensors amount | 100 / 50 / 12 |
| Alarm type | E-mail |
| Optional alarm | SMS notification through USB modem |
| Data storage | 10+ years with 100 sensors |
| Receiver sensitivity | -133 dBm |
| Channels | Channel 1: 868.10 MHz Channel 2: 868.30 MHz Channel 3: 868.50 MHz |
| User interface | Aranet SensorHUB |
| Interface accessibility | PC, tablet or smart phone connected via Ethernet cable or local WiFi connection |
| Temperature scale | Celsius, Fahrenheit, Kelvin |
| Data resolution | Temperature: 0.1° Humidity: 1% |
| Data protection | Password protected user accounts, encryption for data |
| Communication | Ethernet cable, local WiFi |
| Power options | AC Power adapter (12V, 0.5A) Optional power supply with PoE adapter Built in battery (backup power up to 30min) |
| Operating temperature | 0°C to 40°C / 32°F to 104°F |

| Aranet PRO | |
|--------------------|---|
| Operating humidity | 0% to 95% non-condensing |
| Dimensions | 107x170x26 mm/ 4.2x6.7x1.02 in w/o mounting bracket |
| Ports | 1 AC power, 1 Ethernet, 1 USB A |
| Weight | 190g / 6.7oz w/o mounting bracket |
| Construction | ABS Plastic, steel mounting bracket |
| Protection class | IP40 |
| CE marking | Yes |
| Included | AC power adapter (12V, 0.5A), mounting bracket, Aranet SensorHUB software |

Additional Aranet LITE can be used as a monitor.

Terms of use The Customer is obliged to guarantee the usage, maintenance and preservation of the Equipment at their own expense in a way that excludes the Equipment's theft, loss, destruction, harming and/or damaging (including as a result of mechanical damages, moisture, liquid related damages, lightning and/or other similar events). The base station may only be used indoors, it needs to be protected from environmental impact (snow, rain, direct sunlight).

!NOTE! Aranet PRO is supplied with built in UPS providing up to 30 minutes of power supply in case of power shortage. It is meant only as a back up and should be used only during an emergency. If the device discharges the UPS on Power ON position it may suffer permanent damage.



!WARNING! ARANET PRO BASE STATIONS CONTAIN AN LI-ION 14500 PROTECTED TYPE RECHARGEABLE BATTERY AND A CR2032 TYPE BATTERY. RISK OF DAMAGE IF BATTERY IS REPLACED BY AN INCORRECT TYPE. THE USER IS RESPONSIBLE FOR DISPOSAL OF BATTERIES ACCORDING TO THE STATE LEGISLATION.

CONFIGURATION

Router configuration WiFi

There are three options for initial set-up of Aranet PRO. It can be performed by connecting to Aranet PRO WiFi, by connecting Aranet PRO to an internet router via Ethernet cable or directly to a laptop/PC.

!NOTE! Our recommendation is to use the router option, as once Aranet PRO is connected to the local network it will be accessible on any device that is connected to it, as opposed to only being available for devices that are connected to Aranet PRO. It is also a more reliable and robust method of connecting.

How to: Initial setup of Aranet PRO via WiFi

- (1) Plug in Aranet PRO into power source using the included AC power adapter and switch it on.
- (2) Wait until LED indicators next to "12V" and "WiFi" turn on and wait for another 30 seconds.
- (3) Using a smartphone or a PC open the WiFi menu, you should see a new wireless network access point called "Aranet". Connect to it.
- (4) Open internet browser and type in the URL bar IP address: 192.168.206.100
- (5) You should now see the Aranet PRO login screen.

How to: Initial setup of Aranet PRO via router

- (1) Plug in Aranet PRO into power source. It is optional to use a PoE injector or the included AC power adapter. If the power supply is used, plug in an Ethernet cable that connects router to the Aranet PRO. Switch Aranet PRO on.
!NOTE! If PoE injector is used follow the instructions on how to use a PoE injector.
- (2) Wait until LED indicators next to "12V" and "LAN" turn on. Wait for another 30 seconds.
- (3) There are two ways of configuring a router to work with the Aranet PRO base station – static IP and DHCP.
- (4) For static IP set your router IP address to 192.168.205.1 and netmask to 255.255.255.0. Ensure that the DHCP address pool will not collide with Aranet's static IP of 192.168.205.100. Refer to your router's manual, for how to configure these parameters. After performing these changes, Aranet Pro device should be accessible at its default ethernet IP: 192.168.205.100.
- (5) Alternatively you can use the much more widespread DHCP configuration, which entails first connecting to the Aranet Pro base as a WiFi access point and setting the Ethernet interface to DHCP mode. After this is set, you can connect the device to a router which has its DHCP enabled and find the Aranet Pro's IP address in its DHCP Client list. Refer to your router's manual, for how to configure these parameters.

How to: Initial setup of Aranet PRO connected to a Windows PC via Ethernet cable

- (1) Plug in Aranet PRO into power source using the AC power adapter and plug in the Ethernet cable that connects Aranet PRO and PC. Switch Aranet PRO on.
- (2) Wait until LED indicators next to "12V" and "WiFi" turn on and wait for another 30 seconds.
- (3) Make sure the PC is not connected to any WiFi Internet connections.

- (4) In the Control Panel menu choose "Network and Sharing Center" (or "Network and Internet" for Windows 8 and up).
- (5) Click "Change adapter settings".
- (6) Right-click on "Local Area Connection" and click on "Properties".
- (7) Select "Internet Protocol Version 4 (TCP/IPv4)" and click on "Properties".
- (8) Select "Use the following IP Address", set IP address to 192.168.205.101 and subnet mask to 255.255.255.0, leave rest of the fields blank and press "Save".
- (9) Open the Internet browser and in URL bar type the IP address of Aranet PRO: 192.168.205.100
- (10) You should now see the Aranet PRO login screen.

How to: Initial Login

The default user login is:

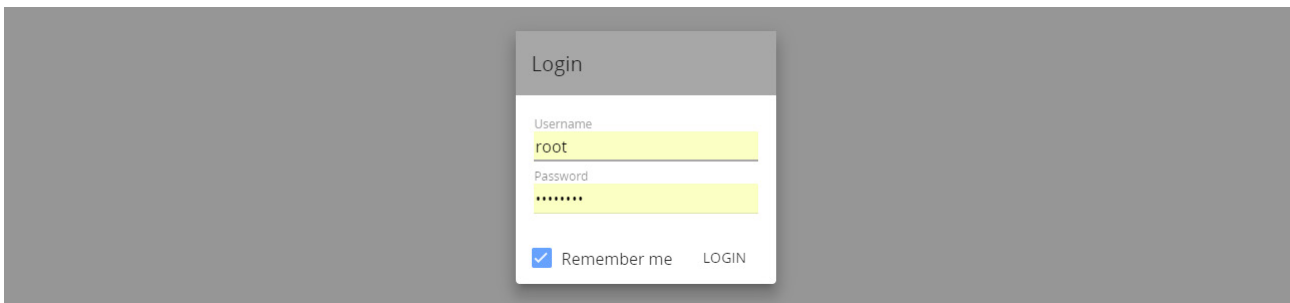

Username: root

Password: changeme



!NOTE! It is an administrator account. We recommend changing the password as soon as possible

We also recommend creating accounts for frequent users as needed.

!NOTE! There are two levels of access - user and administrator. The total account limit is 20.

Recommended network configuration

Once access is gained it is recommended to change the Aranet PRO Network settings under Ethernet from static to DHCP client. This way if the Aranet PRO is connected to a different router it will automatically be given an IP address. To find the device once it is changed follow these steps. Same steps apply when it is connected to a different network.

- (1) Find the IP address of the router (you can usually find this on the router or ask your system administrator/IT support).
- (2) Using a smartphone or a PC that is connected to the router via an Ethernet cable or WiFi open the Internet browser and in URL bar type the IP address of the router.
- (3) Log in the router.
- (4) Once in router menu find DHCP client list.
- (5) By client name find "Aranet", copy the respective IP address.
- (6) Paste the IP address in the URL bar.
- (7) You should now see the Aranet PRO login screen.

SENSOR PAIRING IN ARANET SENSORHUB

How to: Pair sensors to Aranet PRO

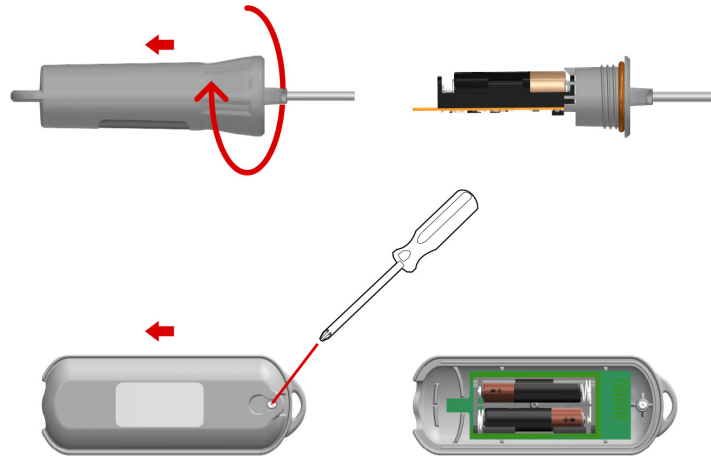

Aranet PRO supports several types of sensors. In order to connect them to the system the same steps apply for all types of sensors.

- (1) You should physically be located within around 20 meters of Aranet PRO.
- (2) In order to open the sensor follow the individual sensor's instructions (see image above). Once it is opened the battery compartment will be exposed.
- (3) Go to Aranet PRO Settings screen.
- (4) Choose "Sensors" menu.

| Sensors | | | |
|---------|-----------------|--------|---------------------|
| | CO ₂ | Name ↑ | Group |
| 25.4°C | 42% | 0011 | Ungrouped |
| 21.9°C | 51% | 0012 | Ungrouped |
| 24.6°C | 47% | 007B | 3rd box (0079-007Z) |
| 24.6°C | 47% | 007C | 3rd box (0079-007Z) |
| 22.6°C | 44% | 007D | 3rd box (0079-007Z) |
| 25.0°C | 46% | 007E | 3rd box (0079-007Z) |
| 24.8°C | 47% | 007F | 3rd box (0079-007Z) |
| 23.9°C | 45% | 007G | 3rd box (0079-007Z) |
| 23.9°C | 45% | 007H | 3rd box (0079-007Z) |
| - | - | 007Y | 3rd box (0079-007Z) |
| 23.9°C | 45% | 007J | 3rd box (0079-007Z) |
| 23.9°C | 46% | 007K | 3rd box (0079-007Z) |
| 24.1°C | 44% | 007M | 3rd box (0079-007Z) |
| 23.1°C | 45% | 007N | 3rd box (0079-007Z) |

(5) Click "Add sensor" button.

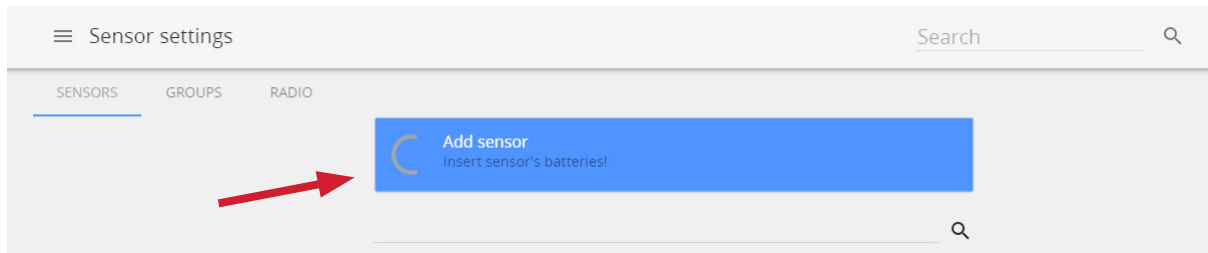

(6) Insert sensor's battery/-ies.

(7) Red LED light will flash on the sensor. Three short flashes followed by a long flash will signal a connection failure, the pause between flashes will be the same. In a successful pairing the long flash will follow immediately after a short flash. Looking at the LED light can save time while pairing sensors, however, Aranet PRO will also display a notification about a successful or unsuccessful pairing.

(8) Close the sensor following respective sensor instructions.

(9) Now you can rename the sensor, set thresholds for alarms, add it to favorites. After completing your tasks click save button.

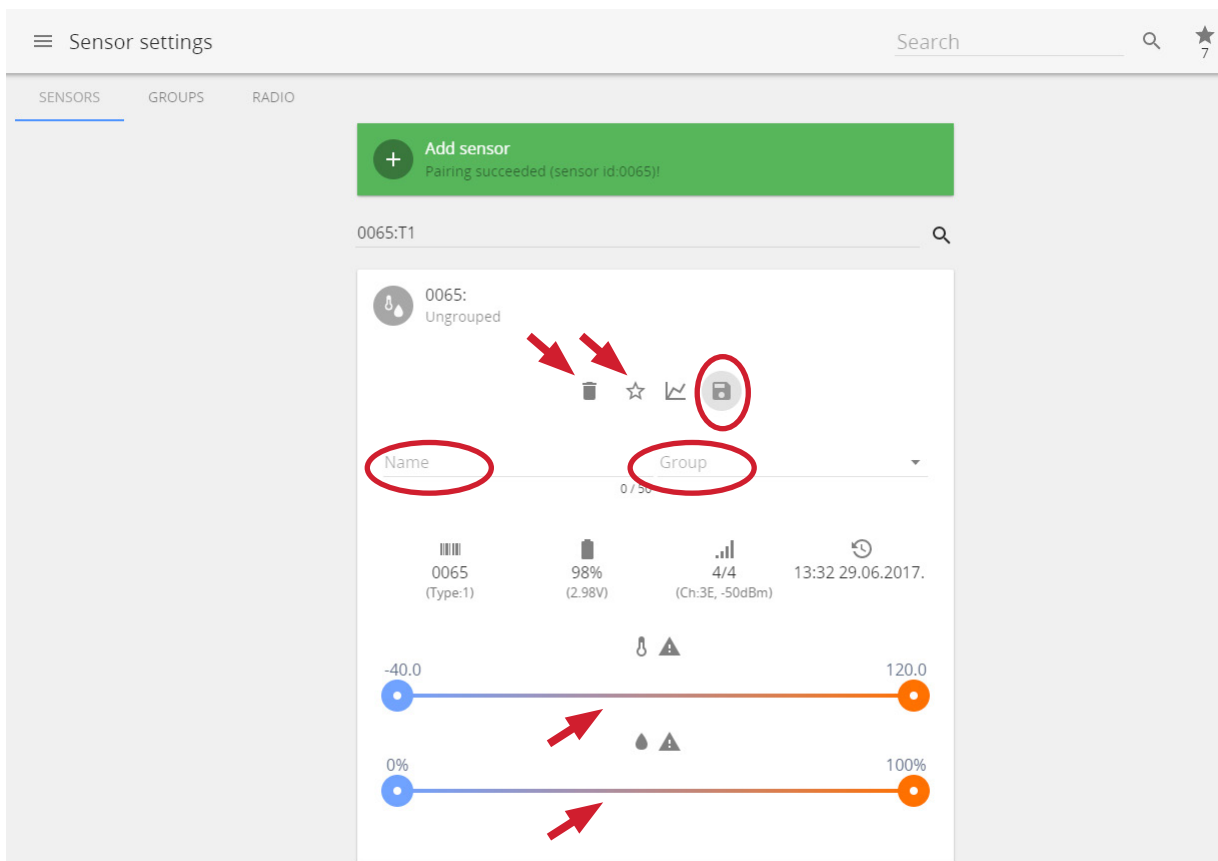

(10) You have now paired a sensor to Aranet PRO and can place it in the desired location.

SENSOR GROUPING IN ARANET SENSORHUB

Aranet SensorHUB allows users to create sensor groups, which can be helpful when managing large number of sensors. Groups can have names, set alert thresholds and choose different alarm types.

How to: Using groups

(1) To create a group go to Aranet PRO Settings screen.

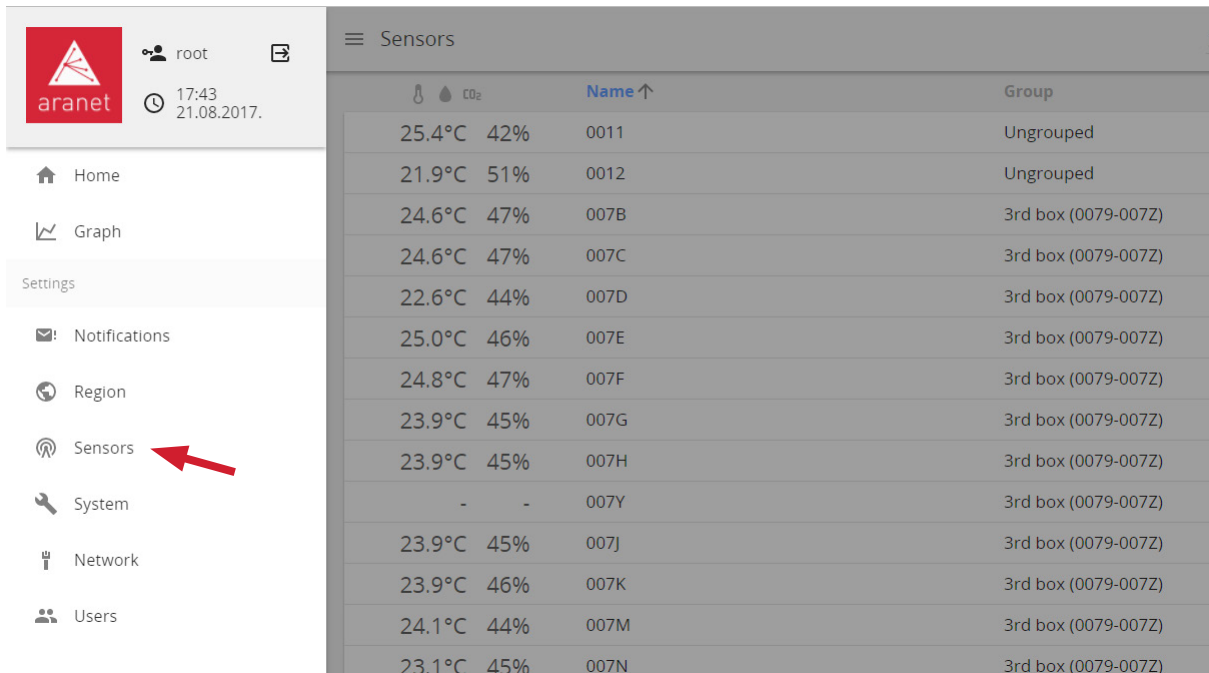

(2) Open "Sensor settings" and choose the "Groups" menu.

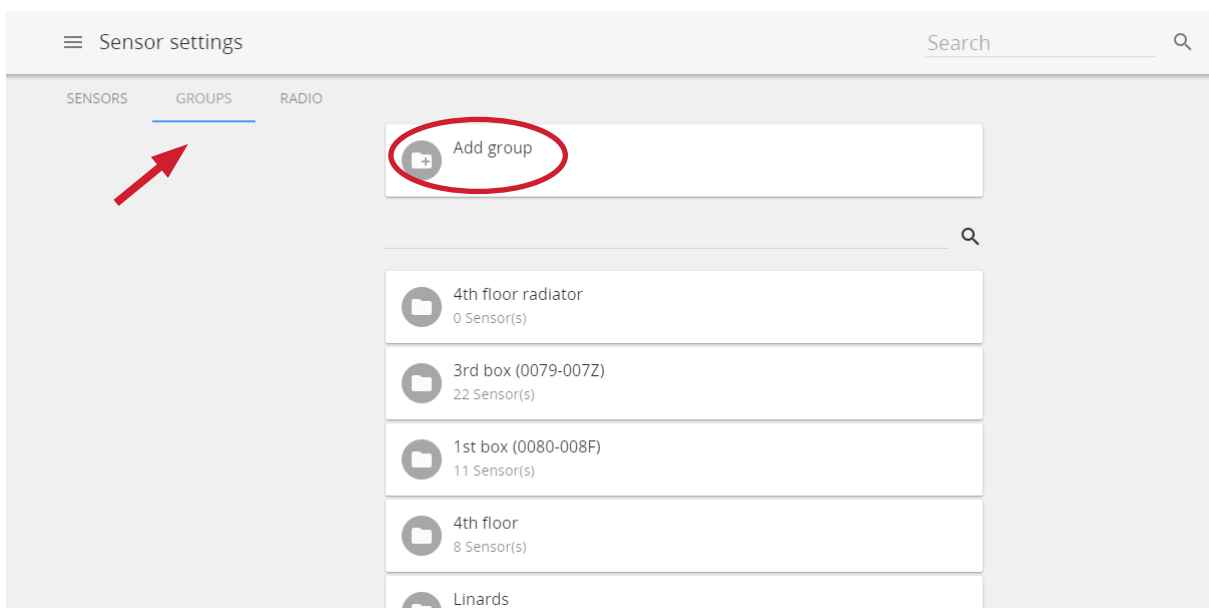

(3) Click "Add group".

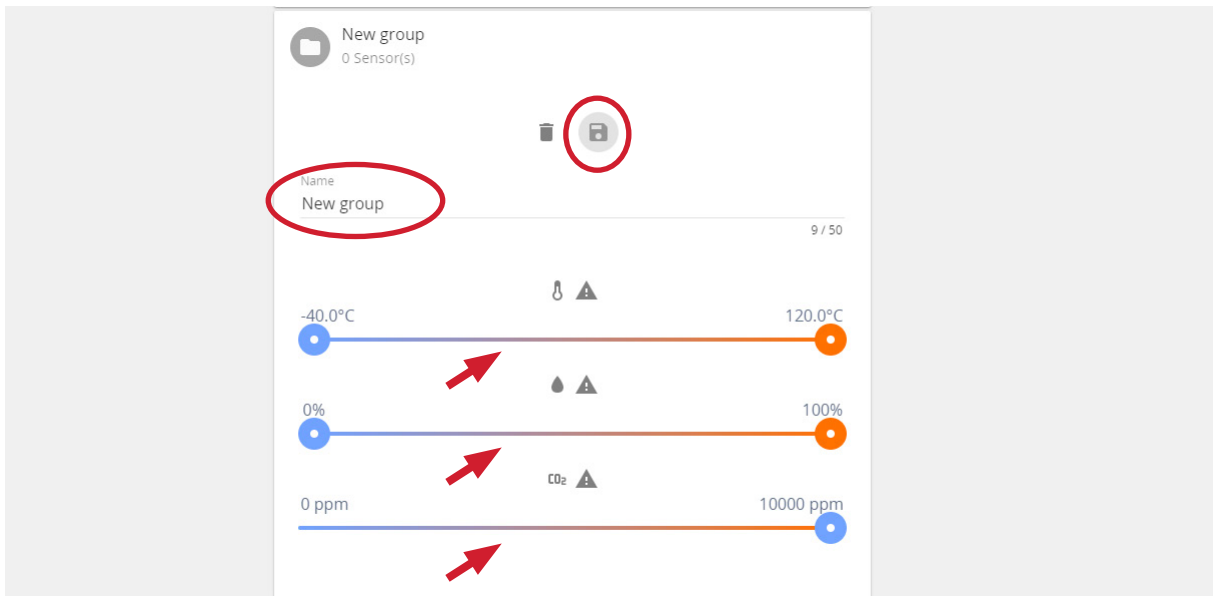

- (4) Now the group can be renamed and thresholds for alarms can be set. These thresholds work for all sensors in the group, unless a sensor is specified to use its own threshold in sensor menu. After editing click the save icon.
- (5) To add sensors to a group choose the "Sensors" menu and click on the item you would like to add.
- (6) In sensor options click on the group drop down menu. Choose the group you would like to add this sensor to.
- (7) In sensor options it is also possible to toggle between sensor thresholds and group thresholds as preferred, so even grouped sensors can have individual thresholds.
- (8) Click the save icon to save changes.

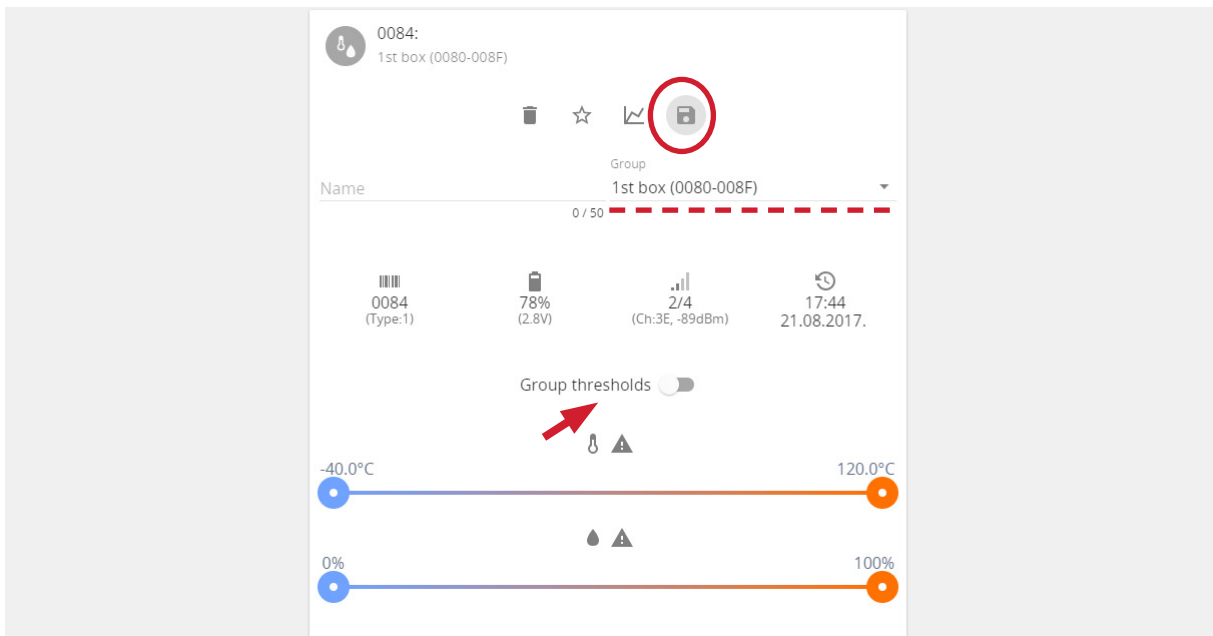

ARANET SENSORHUB OVERVIEW

Main navigation bar

The main navigation bar contains the icon for main menu, indication on which page you are viewing, a search box, favorite and alarm filter icons.

- (1) The search box allows you to quickly view a sensor or sensor group from any menu page. Search function also allows filtering by device type. RH/T Sensor is Type 1, T-Probe sensor is Type 2, CO2 sensor is Type 3. By writing :t<sensor type number> you will filter only sensors of that type to be displayed. Optionally adding a letter or word before will also filter sensors with that letter or name in their name or hex ID. For example command "a:t1" will find all RH/T sensors with letter "a" in their sensor name or hex ID.
- (2) The favorite icon allows you to quickly access all the sensors you have added to your favorite lists.
- (3) The alarm icon allows you to quickly see a list of all sensors that have current alarms and may need attention.

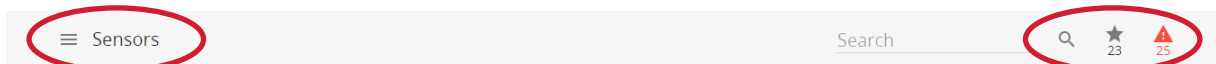

Main menu

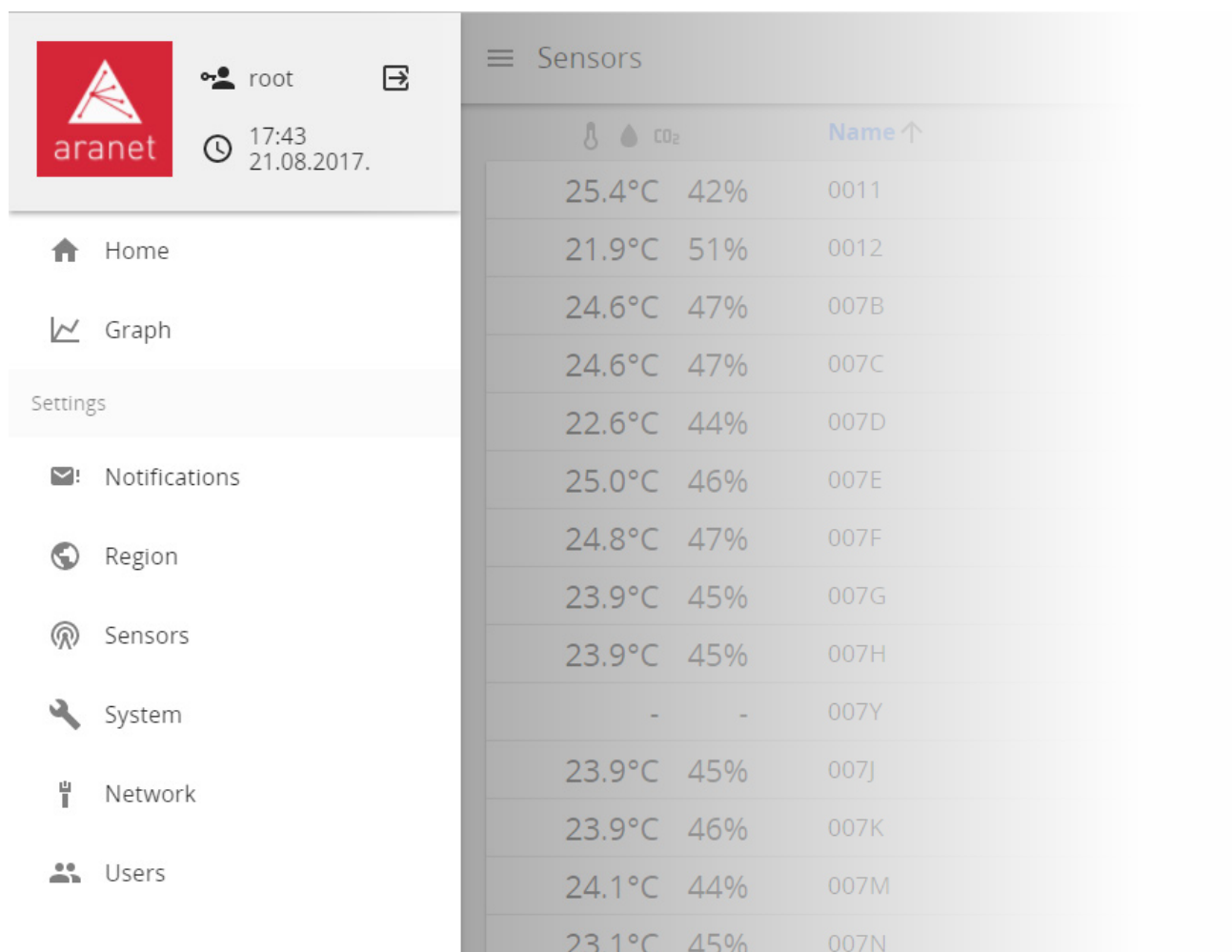
A screenshot of the Aranet SensorHub interface. On the left is a main menu with the Aranet logo at the top, followed by the user "root" and the time "17:43" and date "21.08.2017.". Below this are menu items: Home, Graph, Settings, Notifications, Region, Sensors, System, Network, and Users. On the right is a "Sensors" list. The list has a header with a hamburger menu icon, the title "Sensors", and a "Name" column with an upward arrow. The list contains 14 rows of sensor data, each with a temperature, humidity, and CO2 percentage, and a hex ID. The data is as follows:

| | Temp | Humidity | CO2 | Name |
|--|--------|----------|-----|------|
| | 25.4°C | 42% | | 0011 |
| | 21.9°C | 51% | | 0012 |
| | 24.6°C | 47% | | 007B |
| | 24.6°C | 47% | | 007C |
| | 22.6°C | 44% | | 007D |
| | 25.0°C | 46% | | 007E |
| | 24.8°C | 47% | | 007F |
| | 23.9°C | 45% | | 007G |
| | 23.9°C | 45% | | 007H |
| | - | - | | 007Y |
| | 23.9°C | 45% | | 007J |
| | 23.9°C | 46% | | 007K |
| | 24.1°C | 44% | | 007M |
| | 23.1°C | 45% | | 007N |

Main menu contains following sections - Home, Graph, Notifications, Region, Sensors, System, Network, Users. From these sections you can navigate to all options of the Aranet PRO software.

General information about the user login, current device time and date as well as log off option are displayed here.

- (1) The "Home" menu is the main monitoring page that lists all of the connected sensors. Sensor information is updated with real time data. It is possible to arrange the sensors by highest or lowest measurement values, by name or by group.

| Temperature | Humidity | CO ₂ | Name ↑ | Group | | |
|-------------|----------|-----------------|--------|---------------------|---|---|
| 25.4°C | 42% | | 0011 | Ungrouped | 📄 | ☆ |
| 21.8°C | 53% | | 0012 | Ungrouped | 📄 | ☆ |
| 24.6°C | 47% | | 007B | 3rd box (0079-007Z) | 📄 | ★ |
| 24.6°C | 48% | | 007C | 3rd box (0079-007Z) | 📄 | ★ |
| 22.6°C | 44% | | 007D | 3rd box (0079-007Z) | 📄 | ☆ |
| 24.9°C | 46% | | 007E | 3rd box (0079-007Z) | 📄 | ☆ |
| 24.7°C | 47% | | 007F | 3rd box (0079-007Z) | 📄 | ☆ |
| 23.8°C | 45% | | 007G | 3rd box (0079-007Z) | 📄 | ☆ |
| 23.9°C | 45% | | 007H | 3rd box (0079-007Z) | 📄 | ☆ |
| - | - | | 007Y | 3rd box (0079-007Z) | 📄 | ☆ |
| 23.9°C | 45% | | 007J | 3rd box (0079-007Z) | 📄 | ☆ |
| 23.9°C | 46% | | 007K | 3rd box (0079-007Z) | 📄 | ☆ |
| 24.1°C | 44% | | 007M | 3rd box (0079-007Z) | 📄 | ☆ |
| 23.3°C | 45% | | 007N | 3rd box (0079-007Z) | 📄 | ☆ |

- (2) By pressing on a sensor a submenu opens with sensor information (sensor serial number, name, group, thresholds, last time data was received, battery level, signal strength). All changes for sensor settings can be adjusted here. Graph icon will guide user to the open Graph screen and the favorite icon enables user to add the sensor to favorites.

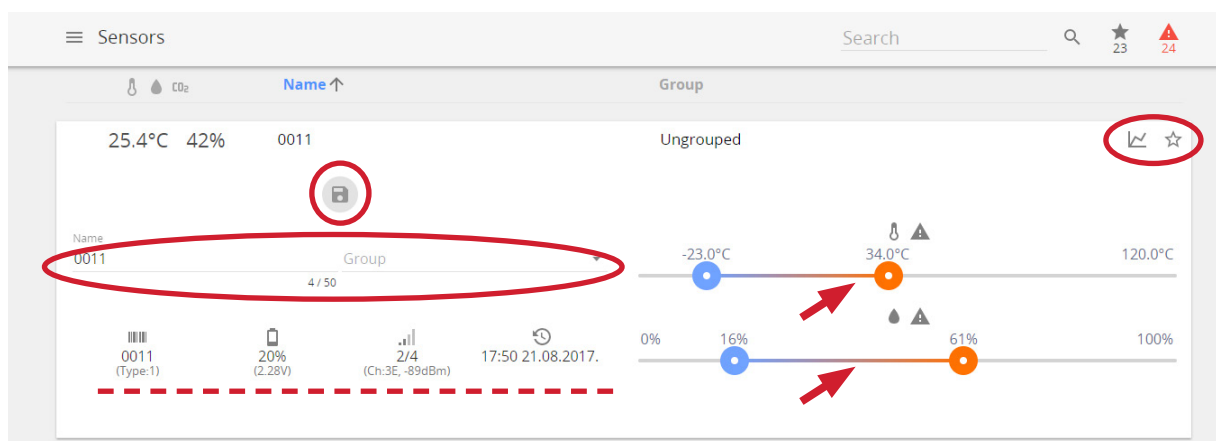

Graphs

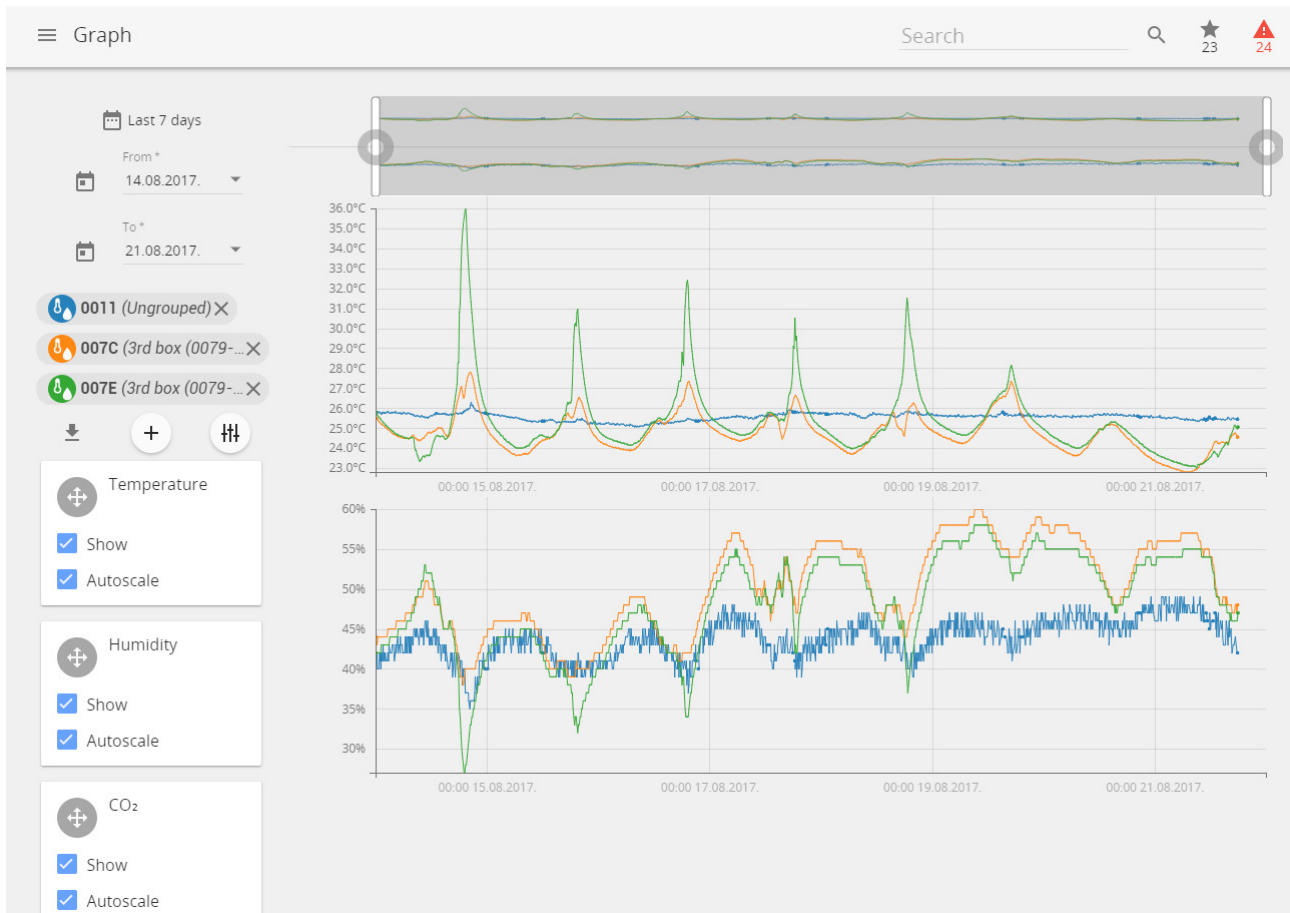

Graph screen enables user to view, compare and analyse the data from the sensors. The "Graph" page enables user to look at historical data, patterns and changes, as well as compare multiple sensor readings over time to see potential correlations.

- (1) Choose which values to graph depending on the attached sensor, and receive as much information as needed.
- (2) Add up to 20 sensors at once for analysis.
- (3) Set custom time period to look for historic data analysis.
- (4) Export data to .csv or .xlsx files by using download button provided.
- (5) A timeline on the top enables zooming in on specific parts of the time period as needed.

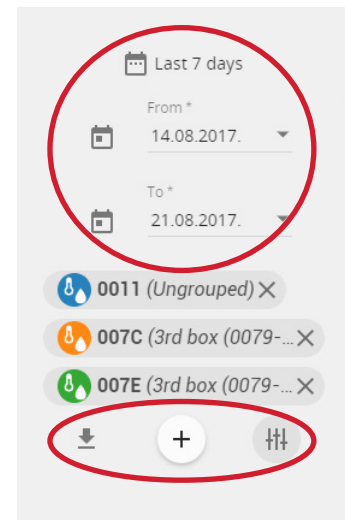

On a desktop PC the timeline zooming into a specific time period can be done with the mouse wheel as well as clicking on the borders of the displayed time period and dragging them. On a mobile device it is possible to use multi touch and panning function with two fingers for navigation.

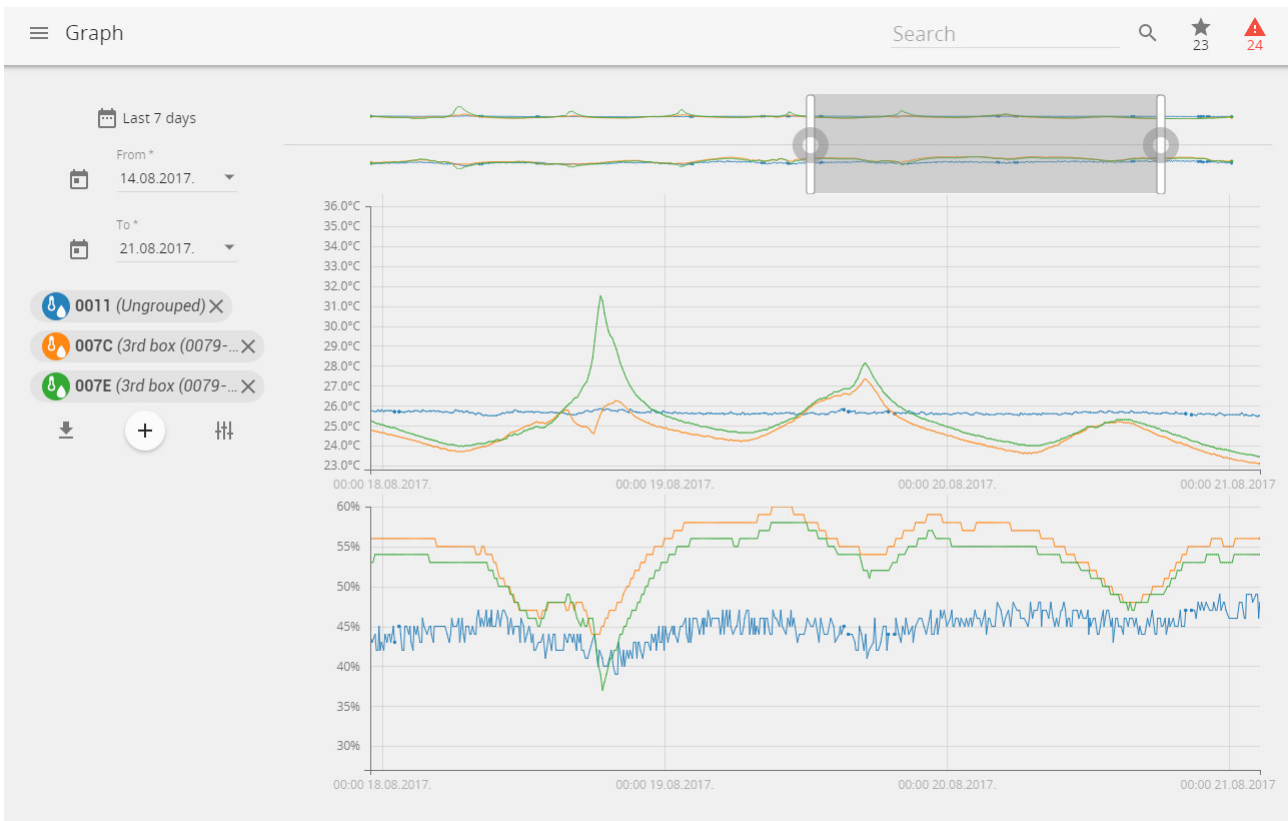

Notifications

“Notifications” menu offers management of alarms and summaries. Aranet PRO offers receiving alarms and summaries via e-mail notifications or text messages.

- (1) The first Sensor screen shows you groups of sensors and allows you to choose individual settings for each group.
- (2) Click icons to receive alarms for thresholds crossed, summaries or both. The icon with exclamation mark represents alarm messages, while the table icon represents summaries.
- (3) If sensors are not added to any group they will be automatically grouped together under “Ungrouped”.

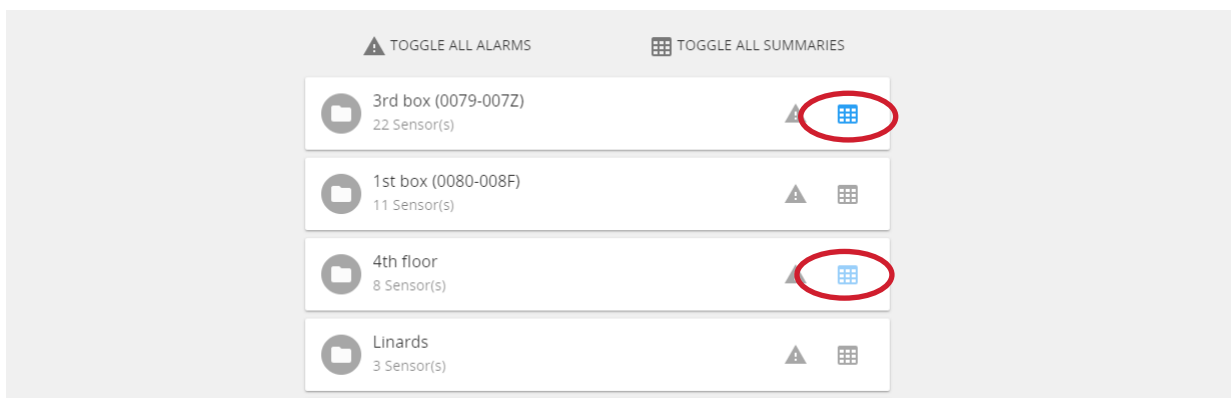

- (4) If you click on the group it will expand to show individual sensors in case you wish to individually manage which sensors you will be notified about.
- (5) The "Settings" screen is where you can choose if you want to receive notification via email, text messages or both, and what type of notification to receive.
- (6) Input your email address and phone number to receive the notifications.
- (7) Save changes once you've completed all tasks.

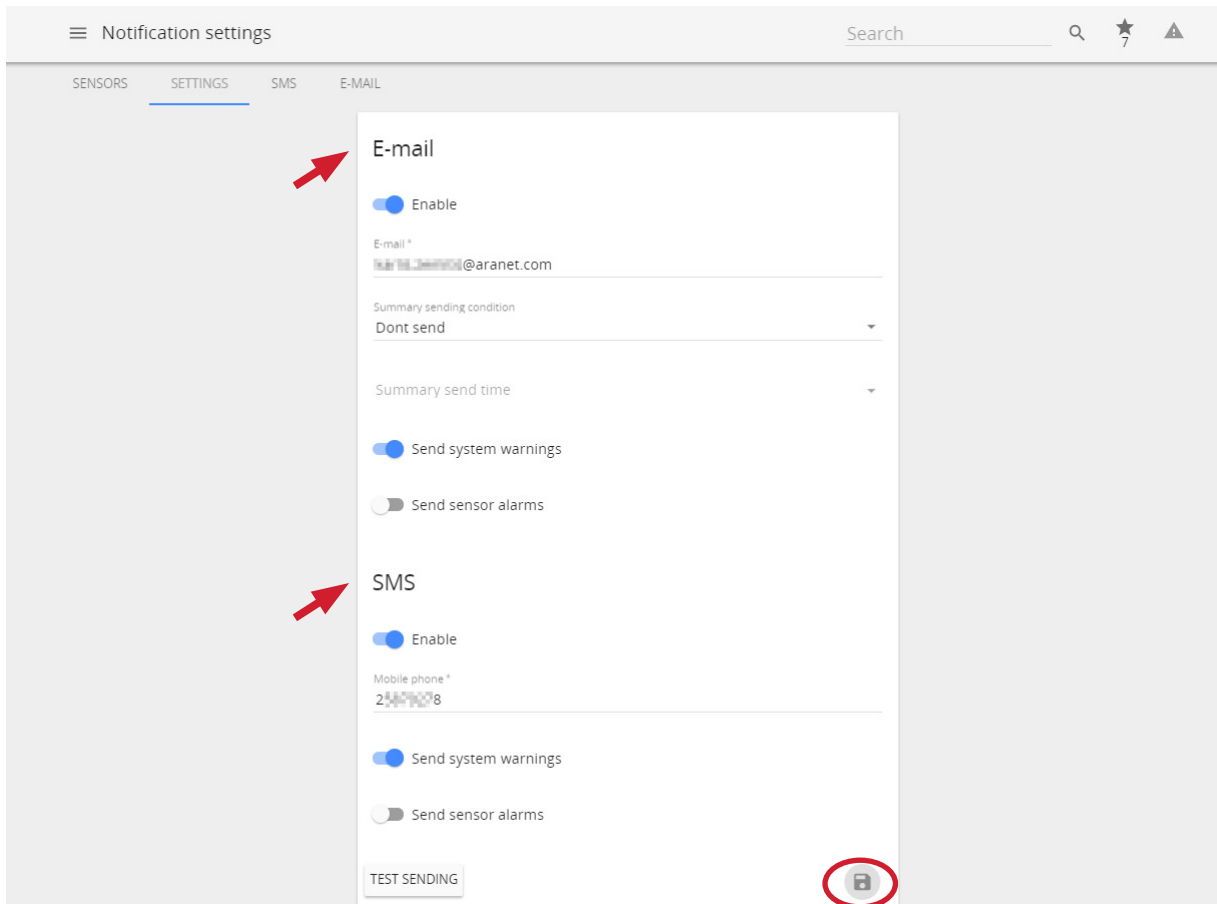

SMS screen

The SMS screen is where you can set up SMS alert functionality. SMS functionality is enabled if you have a GSM modem with an active SIM card connected to Aranet PRO.

Please find information about the supported GSM modems here:

<https://aranet.com/product/wireless-iot-base-station/>

!NOTE! The SIM card cannot be activated through Aranet PRO software, the card can only be unlocked with the PIN code, so it must be pre-activated.

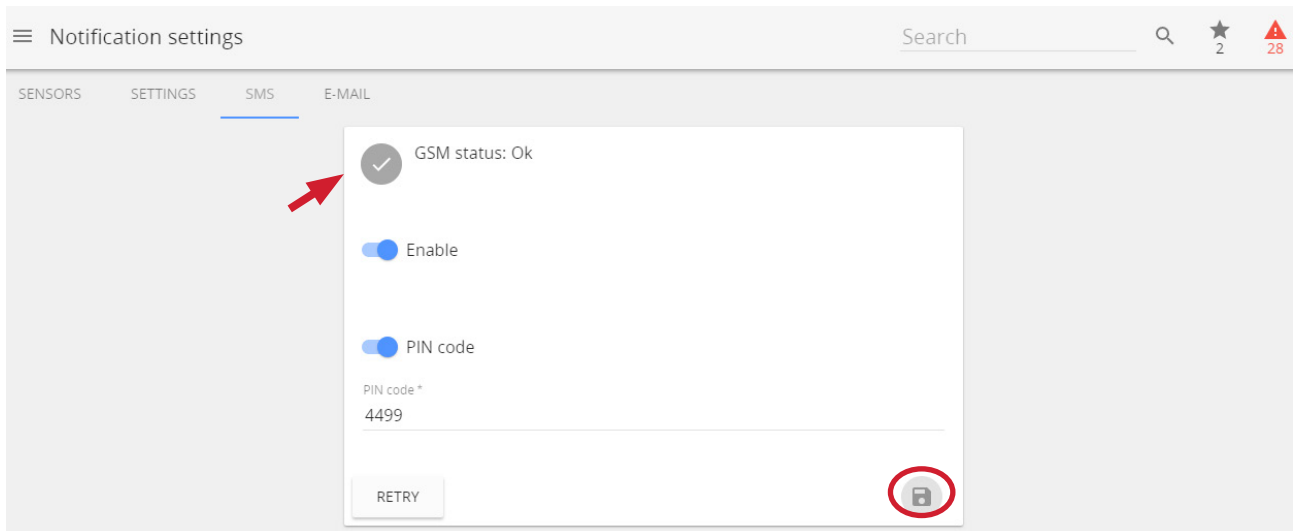

E-mail screen

The email screen is where you set up the email from which the notifications will be sent.

There is support for Gmail, Outlook and Yahoo accounts, however a Custom SMTP provider can also be set up.

Once all the required information is filled out and the connection is tested you can start receiving E-Mail alerts and summaries.

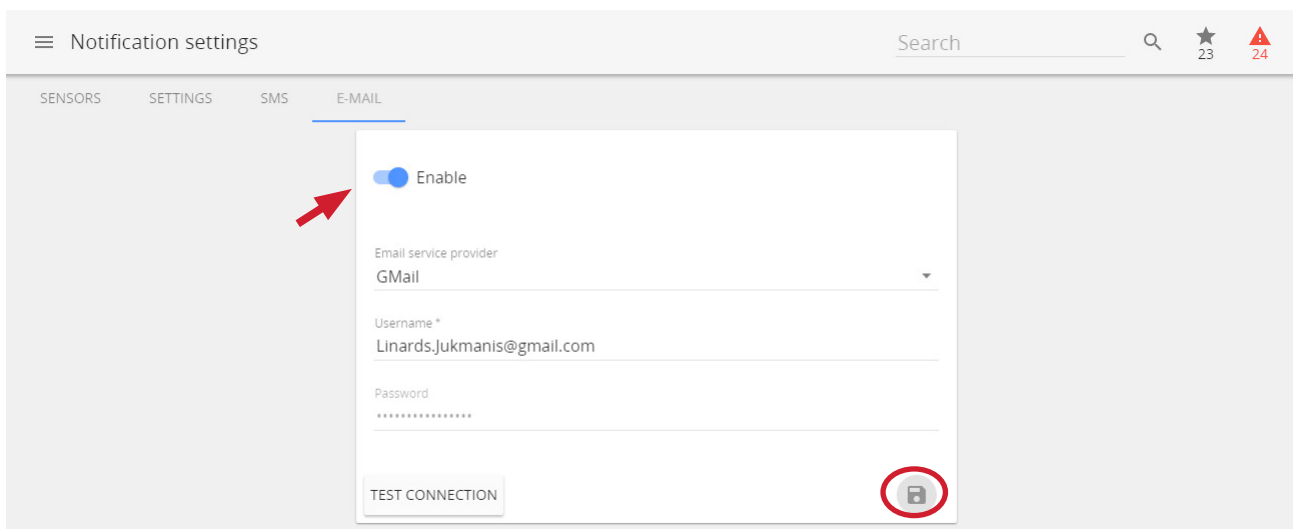

Region

The “Regional settings” menu is where the interface of Aranet PRO can be set up with the preferred language, temperature scale and time and date settings.

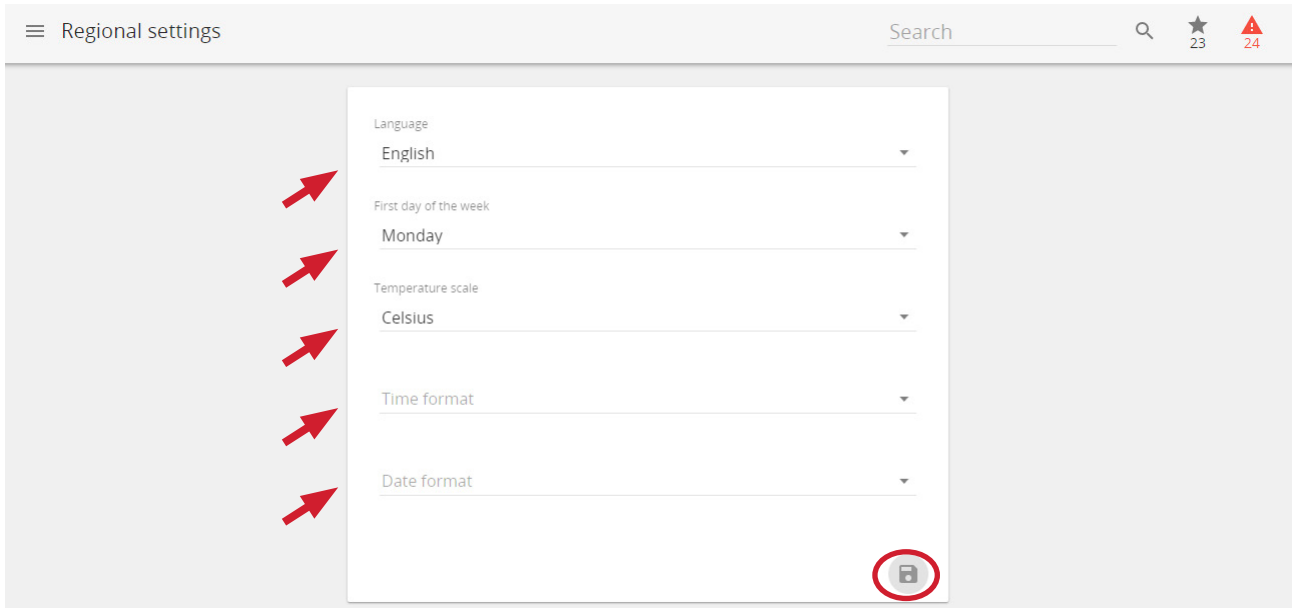

Sensor

Sensor settings is where sensors can be paired and the sensor information, such as group, name and thresholds, can be adjusted (“Sensor pairing” and “Sensor grouping “ section).

Radio menu

Radio menu allows to perform a channel scan in each of the available channels for your region.

If the area has a dense coverage of sensors from other base stations this can become important.

!NOTE! If sensors are already paired to Aranet PRO they will also show up as interference in the radio scan of the channel currently in use. We recommend choosing the channel with the highest availability to ensure that you receive reliable data stream from the sensors and avoid data loss. A channel scan takes 60 minutes during which it is not possible to pair new sensors to the base station.

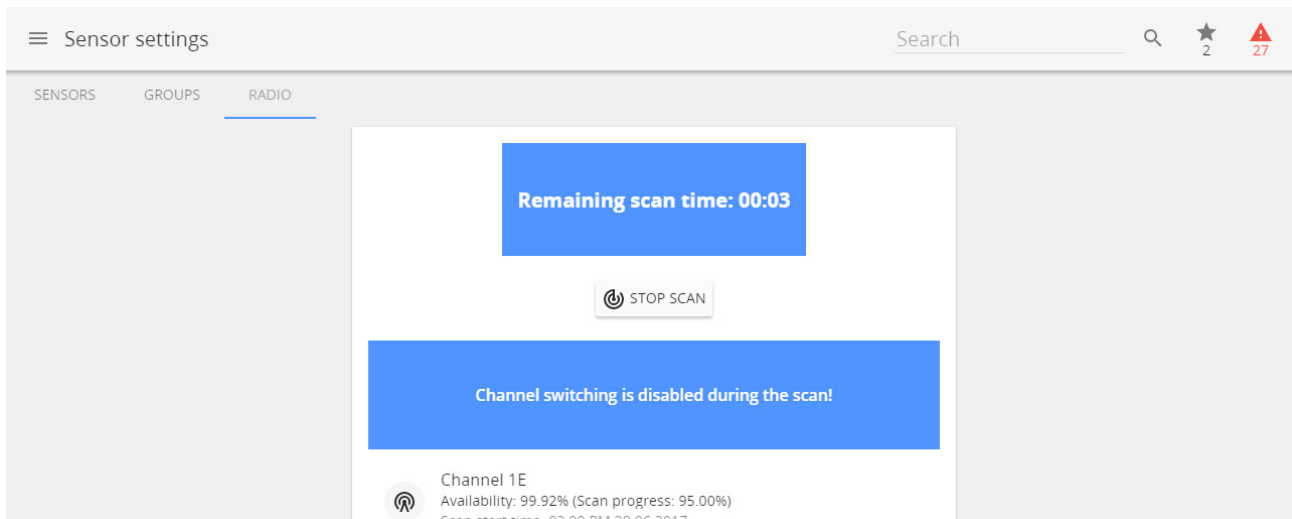

System

“System settings” screen is where you will find critical information and options for your Aranet PRO. The status screen is a status information screen that will provide you with information about the Aranet PRO.

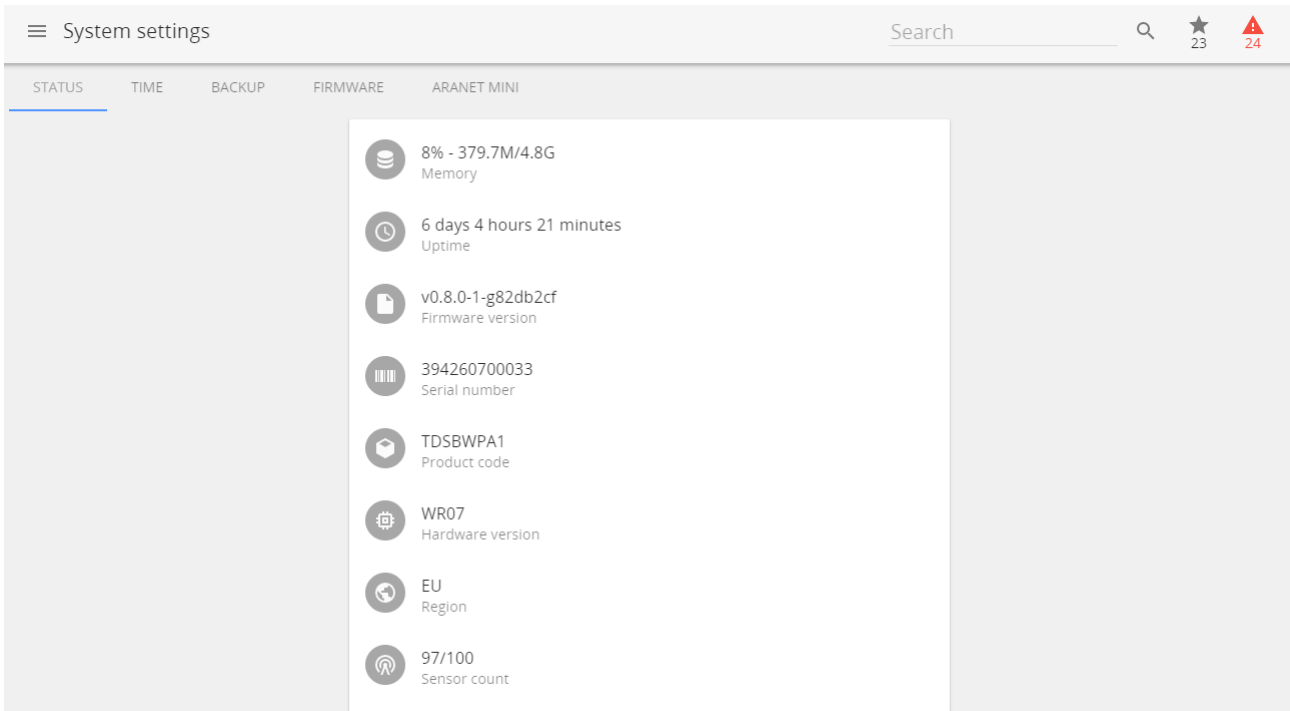

Time menu

By default Aragnet PRO uses the local devices time settings, however it is possible to change the time and set it up manually, if it is preferred, as well as to use an NTP server for time synchronisation.

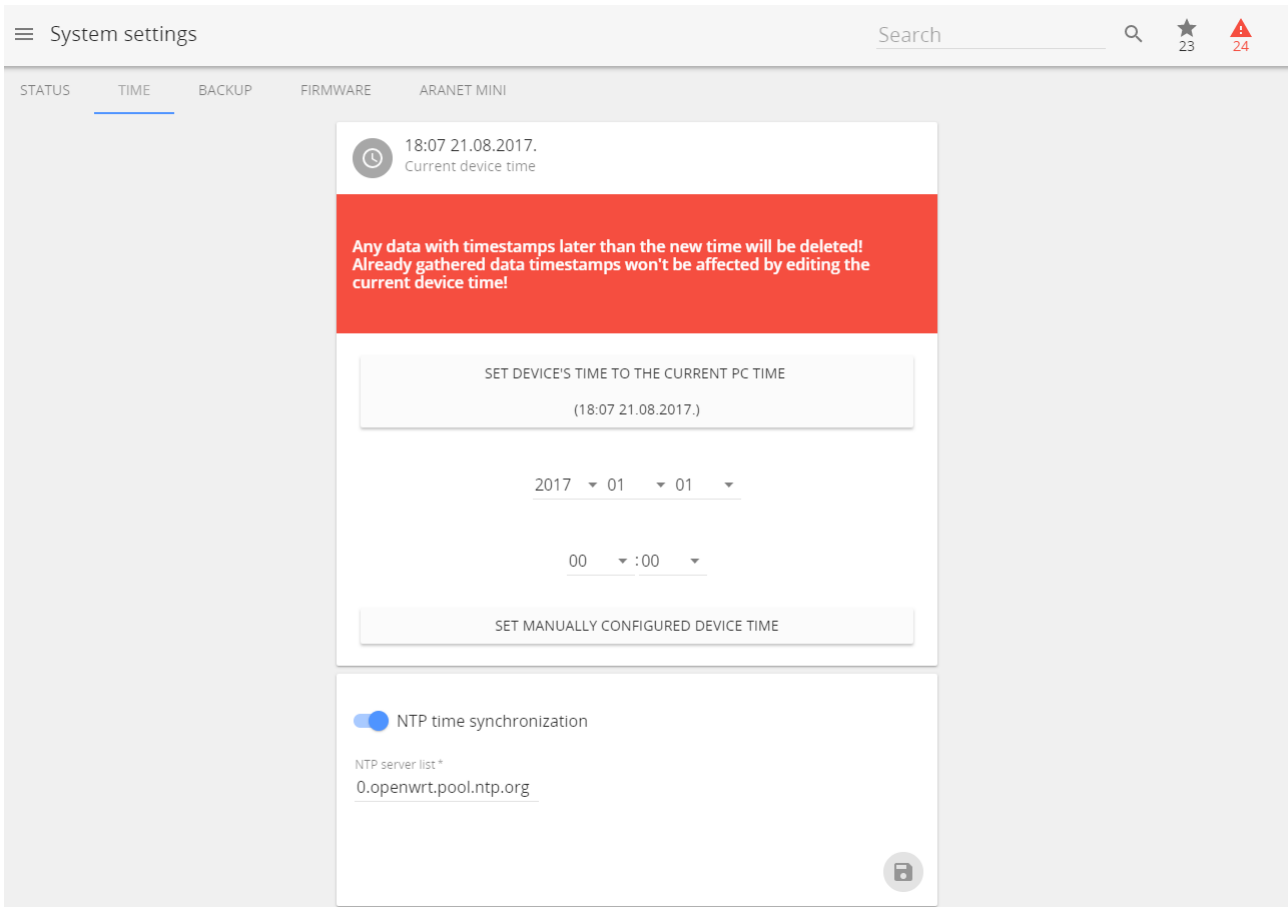

!NOTE! If device time is adjusted backwards, any data previously gathered with a timestamp later than the newly set time will be discarded.

Backup menu

The backup menu is where user can create a back up for device settings. In order to perform a back up just click the “Export Backup” button and a file will automatically be downloaded. It enables quick cloning of settings and sensors of current Aranet PRO for either duplication reasons, or if full factory reset is necessary, which also can be performed in this menu. In order to upload a back up file click on “Import Backup” and locate a back up file. Once that is done click the upload icon next to it.

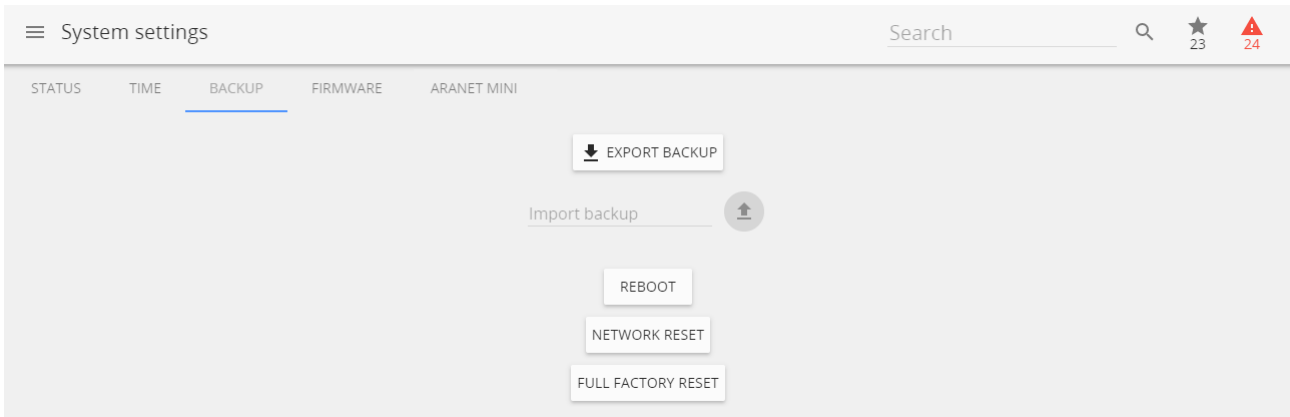

!NOTE! It is important to remember that the gathered data will not be saved in the back up - it needs to be exported in case you wish to save it.

Other options, such as remote reboot and network reset are also available here. Network reset will load the default network settings for Aranet PRO and can also be performed by a network reset button on Aranet PRO by holding it for 5 or more seconds, however that will also reset the root user password. Full factory reset will delete all the data and reset Aranet PRO to default settings.

Firmware menu

The firmware submenu shows current software version and allows to update it. In order to update firmware download the firmware update from www.aranet.com, then click on the “Choose firmware file” text box and locate the file on the PC. Once that is done press the upload button next to it.

!NOTE! The software update usually takes about two minutes to be completed. During that time the device will reboot in order to complete the update.

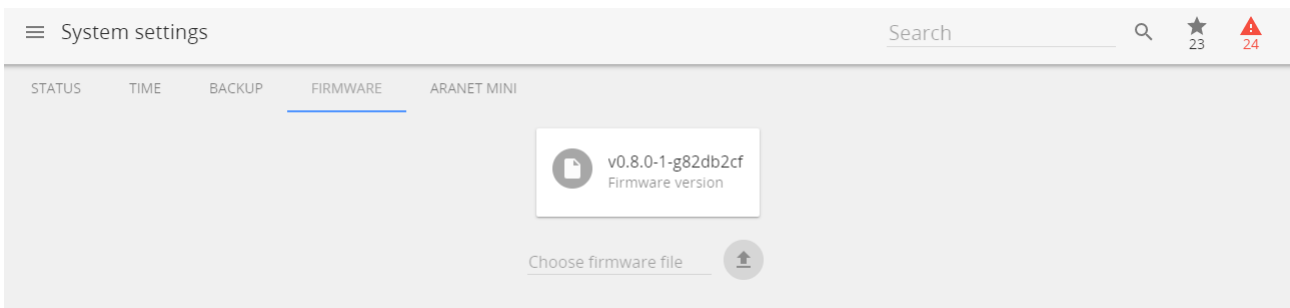

!NB! Aranet PRO firmware upgrade file name should not be changed, as it might not be recognized otherwise.

Aranet MINI monitor mode – Aranet LITE

There are two ways to configure Aranet MINI to work as Aranet LITE.

1st way – Using a desktop PC

- (1) To configure Aranet MINI into LITE you need to log in Aranet PRO using a desktop PC and choose the Monitor mode in System settings menu, submenu Aranet Mini.
- (2) Choose the sensors you wish to display on Aranet LITE (up to 12 sensors) by selecting the (+) buttons and press the “Download Configuration” button.
- (3) The settings file is then saved on your computer and needs to be transferred on Aranet Mini to enable the LITE functionality. Aranet Mini should be connected to a free USB port on the computer using the included USB cable. It will automatically recognize Aranet Mini as a storage device. The downloaded file needs to be transferred to the Aranet Mini main file directory, settings will automatically be applied to Aranet Mini once that is done. !NOTE! Aranet MINI/LITE only supports Aranet T/RH sensor, Aranet PT100 sensor, Aranet PT100 transmitter, Aranet T Probe sensor and Aranet CO2 sensor.
- (4) To return full Aranet MINI functionality check the Standalone mode in the same Aranet PRO menu and repeat steps 2 (without choosing sensors) and 3.

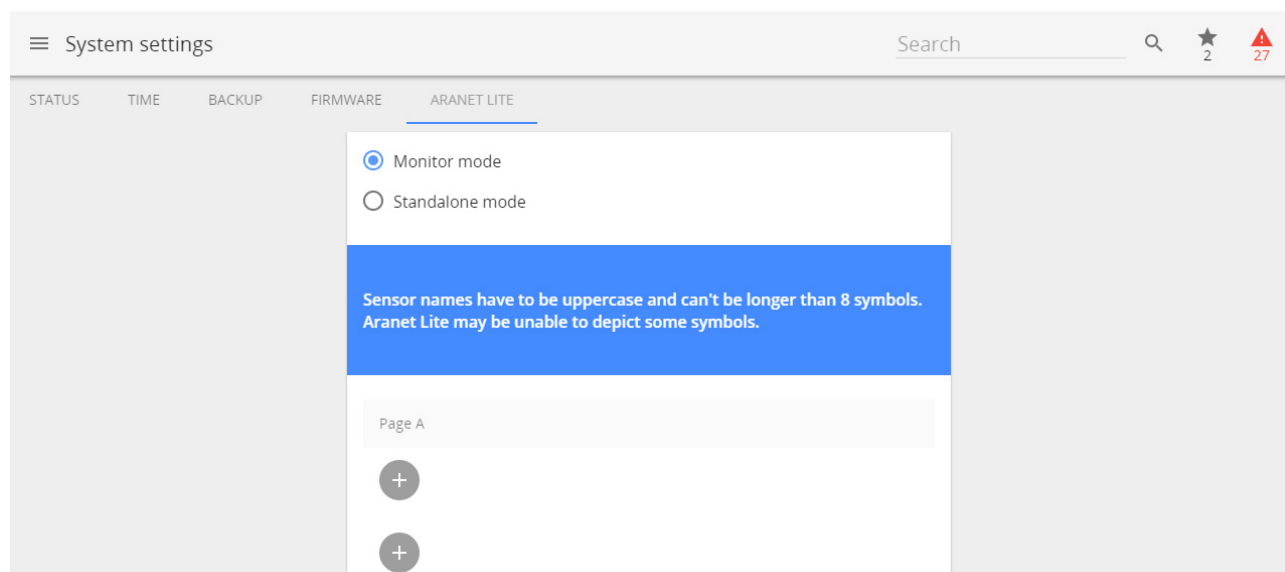

2nd way – Directly from Aranet PRO to Aranet MINI

- (1) To configure Aranet MINI into LITE you need to log in Aranet PRO using a desktop or a smart device and choose the Monitor mode in System settings menu, submenu Aranet Mini.
- (2) Choose the sensors you wish to display on Aranet LITE (up to 12 sensors) by selecting the (+) buttons.
- (3) Aranet Mini should be connected to the USB port on the Aranet PRO using the included USB cable. The “Upload via USB” button will become available, by pressing on it the settings will automatically be loaded on Aranet Mini. !NOTE! Aranet MINI/LITE only supports Aranet T/RH sensor, Aranet PT100 sensor, Aranet PT100 transmitter, Aranet T Probe sensor and Aranet CO2 sensor.
- (4) To return full Aranet MINI functionality check the Standalone mode in the same Aranet PRO menu and repeat step 3.

Network

The Network settings menu is where you can configure the connectivity of Aranet PRO. WiFi and Ethernet connectivity is supported for connecting to the internet, however Ethernet connectivity is preferred for stability.

WiFi menu

By default Aranet PRO is configured as a WiFi access point for easy initial configuration. However, if you wish this can be changed. The first menu screen is for the WiFi setup where you can choose between Access Point and Client connectivity.

- (1) In Access point connectivity it is possible to add password to your Aranet PRO WiFi, as well as change its name, IP address and subnet mask.

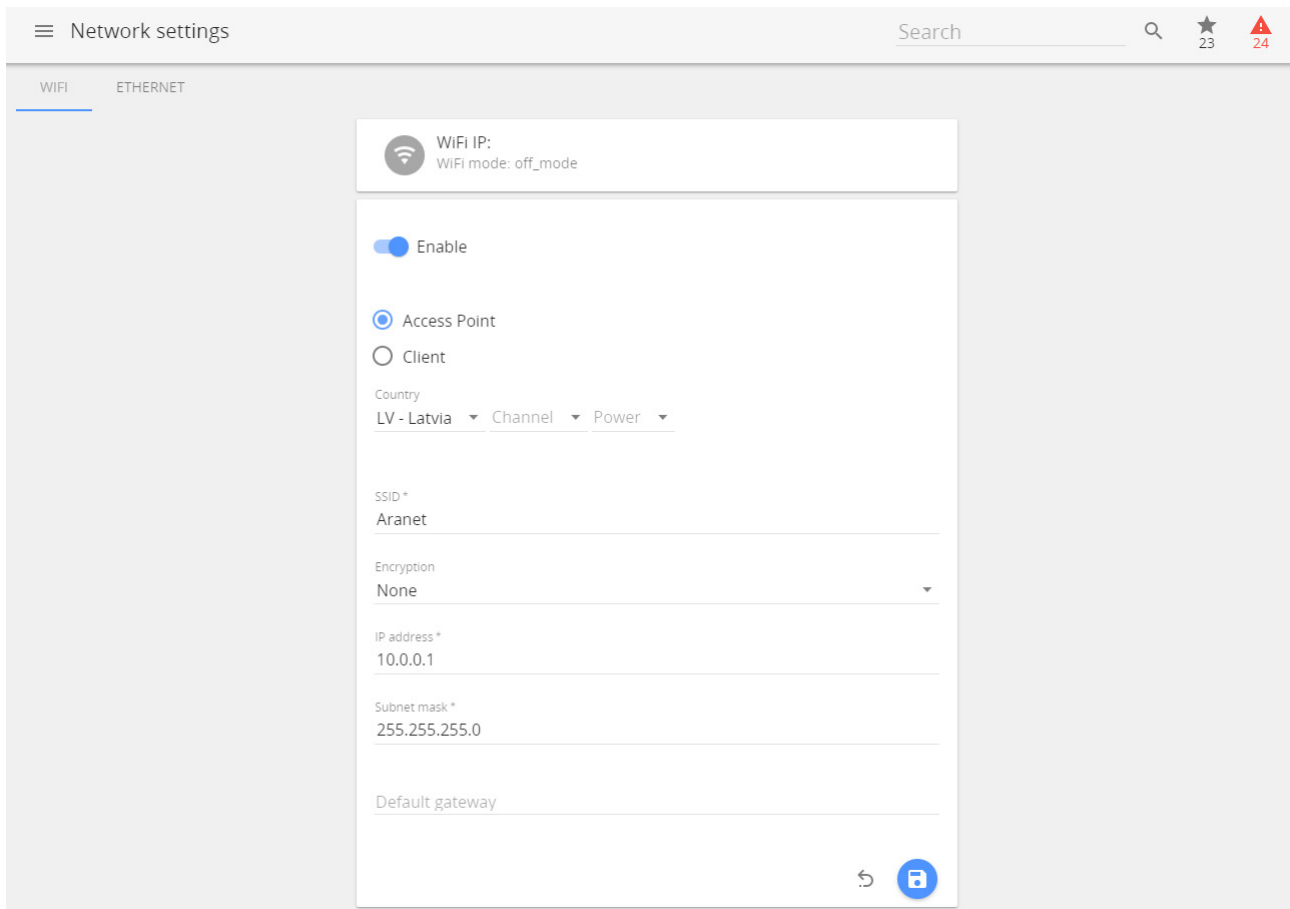

The screenshot shows the 'Network settings' interface with the 'WiFi' tab selected. The 'WiFi IP' section is visible, showing 'WiFi mode: off_mode'. Below this, there is a toggle for 'Enable' which is turned on. Underneath, there are radio buttons for 'Access Point' (selected) and 'Client'. The 'Country' is set to 'LV - Latvia', with 'Channel' and 'Power' dropdown menus. The 'SSID' is 'Aranet', 'Encryption' is 'None', 'IP address' is '10.0.0.1', and 'Subnet mask' is '255.255.255.0'. There is a 'Default gateway' field which is currently empty. At the bottom right, there are icons for a refresh button and a save button.

- (2) In case you wish to connect Aranet PRO to a local WiFi network choose the Client mode, find the appropriate WiFi connection and fill in the WiFi password.

!NOTE! Most routers have DHCP enabled by default, we recommend keeping this setting for ease of set up. For advanced users, however, static IP address set up is possible.

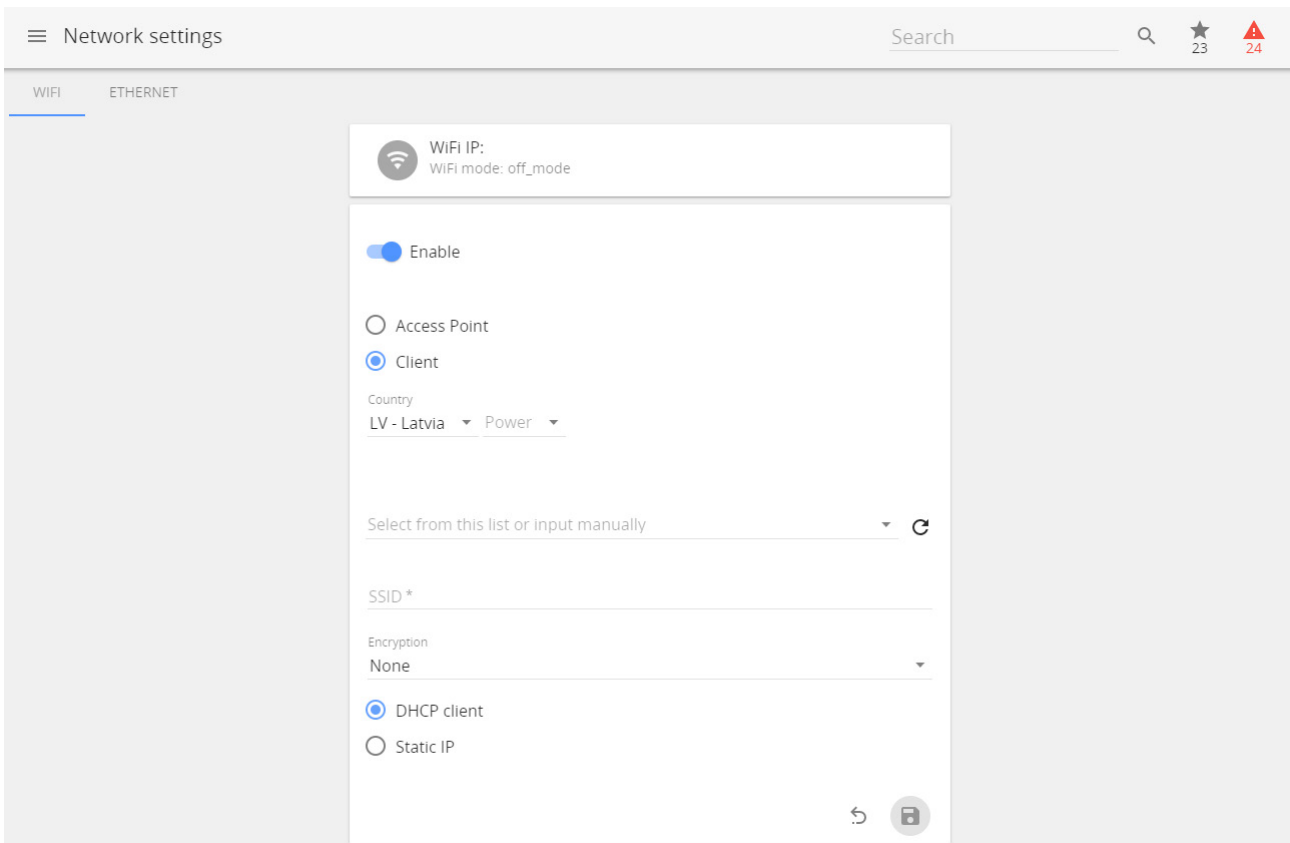

Ethernet menu

Ethernet connection is preferred for Aranet PRO, as it is generally more reliable. In the Ethernet menu there are only two options - either to have it work in DHCP client mode or have a Static IP.

!NOTE! Most routers have DHCP enabled by default, we recommend keeping this setting for ease of set up. For more advanced users, however, static IP address set up is possible.

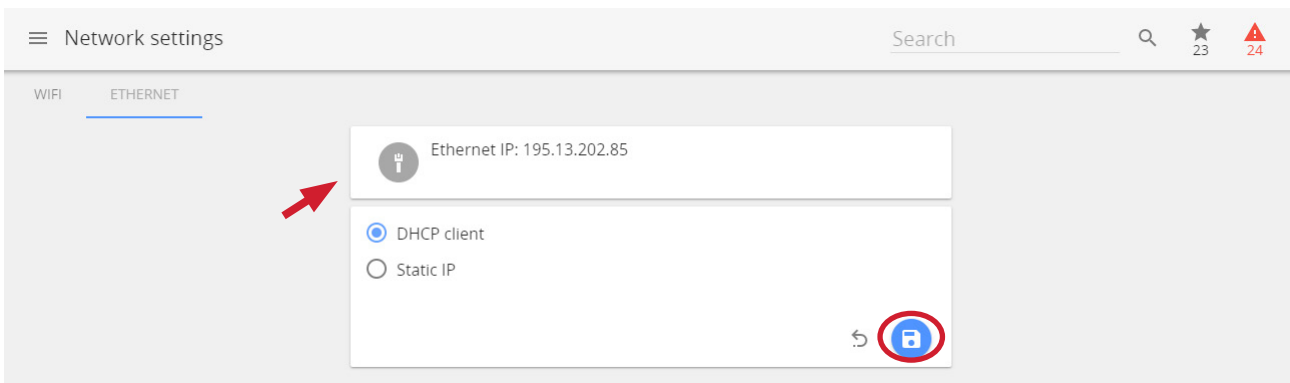

Users

The "User settings" is where you can create new users and edit the data about existing ones. There are two types of accounts - User and Administrator.

The User account has limited access to many of the settings' features, however full access to data and sensors is granted.

The Administrator account should only be given to those who need features, such as software update, network reset etc.

Passwords can also be set up and changed here.

!NOTE! Change the root user password! Default password is a placeholder that is well known and should only be used for initial setup or after resetting to factory defaults.

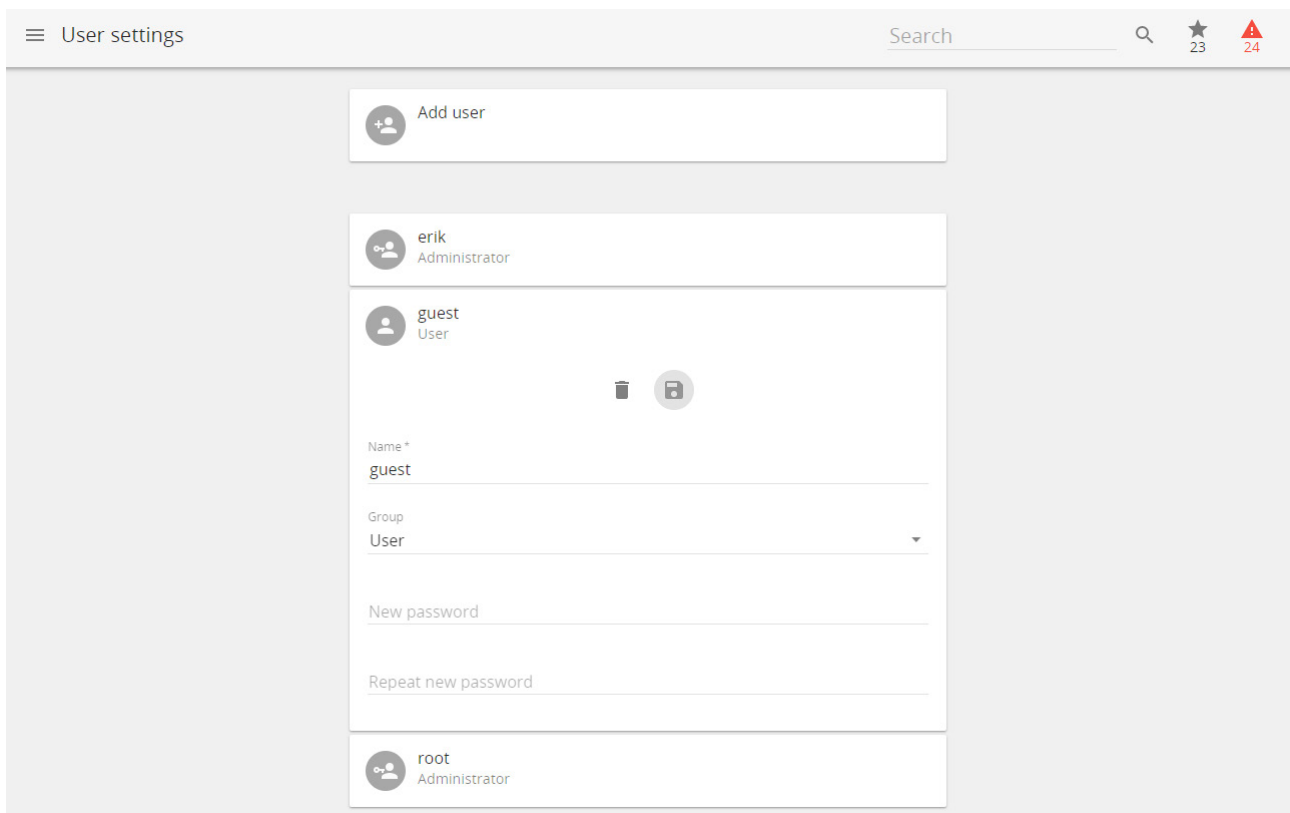

TERMS OF USE

Aranet PRO base station - The Customer is obliged to guarantee the usage, maintenance and preservation of the Equipment at their own expense in a way that excludes the Equipment's theft, loss, destruction, harming and/or damaging (including as a result of mechanical damages, moisture, liquid related damages, lightning and/or other similar events). Base station may only be used indoors, it needs to be protected from environmental impact (snow, rain, direct sunlight).

!NOTE! For the full Terms and Conditions, please visit: <https://aranet.com/terms-and-conditions/>

WARRANTY

ARANET WARRANTY

SAF, which includes SAF Tehnika and SAF North America, LLC, has built a reputation on providing high-quality products to its customers and it stands behind each product it manufactures, including Aranet. Accordingly, SAF warrants the products it manufactures will be free from defects in material or workmanship and will function in accordance with their official written specifications for a minimum of two years as long as they are used and stored in accordance with industry standards and any unique handling instructions provided by SAF. While SAF warrants all of its products will function in accordance with their official written specifications, SAF does not warrant all products will function uninterrupted or error free. Further, verbal or informal specifications will not be covered by the Warranty. To be enforceable, a product specification must be stated in SAF official literature. No product shall be considered defective or otherwise in breach of the Warranty simply because it needs to be adapted to or otherwise does not comply with the laws and regulations (including frequency range) of the customer's home country or jurisdiction.

WARRANTY TERM

The Warranty shall apply to Aranet 24 months after it is shipped to the customer. An invoice itemizing a product's warranty period shall be included with the product when it is delivered to the customer. No verbal extensions or modifications of the Warranty shall be enforceable.

WARRANTY LIMITATIONS

The Warranty shall be voidable at SAF's discretion in any circumstance where a SAF manufactured product has been damaged by a customer's conduct or an act of God including, but not limited to: a.) damage caused by the customer's improper use of the product; b.) mechanical damage caused by a physical impact; c.) the accumulation of moisture or water in a product's housing; d.) damage caused by wind, hail, rain, animal, insect or other environmental events; and e.) electromagnetic damage caused by a power surge, overvoltage, or a strike of lightning. Finally, for the Warranty to be effective, all repairs and modifications to a product, including its software, must be performed by SAF and the Warranty shall be voidable at SAF's discretion in any circumstance where a customer or its agent opens a product's housing or otherwise attempts to modify or repair a product, including its software, without SAF's permission. There are currently no third-parties authorized to repair SAF's products.

Product Repairs & Liability Limitations

In the event a SAF manufactured product does not conform with the Warranty, SAF will fix or replace the non-functioning product in accordance with the return and repair policy below. These options shall be a customer's sole remedy.

IN NO EVENT SHALL SAF BE LIABLE FOR ANY INDIRECT, INCIDENTAL, SPECIAL OR CONSEQUENTIAL DAMAGES ARISING OUT OF OR RELATING TO THE SALE OR USE OF ITS PRODUCTS, WHETHER OR NOT SAF HAS ADVANCE NOTICE OF THE POSSIBILITY OF SUCH DAMAGES. SAF'S SOLE AND EXCLUSIVE MAXIMUM LIABILITY FOR ANY LEGAL CLAIM ASSOCIATED WITH A SALE COMPLETED PURSUANT TO THESE TERMS OR THE WARRANTY, REGARDLESS OF WHETHER SUCH CLAIM SOUNDS IN CONTRACT OR TORT, LAW OR EQUITY, SHALL NOT EXCEED THE PRICE OF THE PRODUCT(S) SOLD TO A GIVEN CUSTOMER. BY SUBMITTING THEIR PURCHASE ORDER, EACH CUSTOMER KNOWINGLY WAIVES ANY AND ALL CLAIMS AND DAMAGES PRECLUDED BY THE FOREGOING LIMITATIONS INCLUDING, BUT NOT LIMITED TO, ALL CLAIMS ASSOCIATED WITH PERSONAL INJURIES (INCLUDING ANY CLAIMS BASED IN PRODUCT OR STRICT LIABILITY), LOST REVENUE AND PROFITS, LOSS OF TECHNOLOGY, LOSS OF RIGHTS OF SERVICES, UNFAIR COMPETITION AND COMMERCIAL LOSSES OF ANY KIND.

ACCEPTANCE, RETURNS & REPAIRS

If Customer has not received the goods he can contact SAF to help solving the problem. The claim of non-received goods should be raised within 60 days from the date of payment. No assistance will be available after the term of 60 days has passed. Prior to raise a claim to SAF, Customer should ascertain that a parcel is not received by any other person in Customer's premises. Also, Customer is asked to ascertain that a parcel is not left at any of the neighbours, etc.

SAF keeps the right to perform an investigation for a period of 20 days. In the case SAF has made a decision to compensate Customer for the losses, either a new product may be sent to customer or the price for the ordered product may be returned to Customer.

If Customer is not satisfied with a received product, he can proceed as described further. Restocking and Refund is not applicable for legal entity.

Physical person which is a resident of US and Canada may require Restocking and Refund within 60 days from the date of payment. No Restocking and Refund will be available after the term of 60 days has passed.

Physical person which is a resident of any country outside US and Canada may require Restocking and Refund within 14 days from the date of payment. No Restocking and Refund will be available after the term of 14 days has passed.

No more than one product (set), or a product for a price exceeding EUR 700 or USD 750 can be Restocked.

If the Restocking is accepted by SAF, the product(s) must be returned – unused, condition as brand new, without any defects, without dirt and scratches, containing all original labels, full completion as received, in original package as received. The shipment back to SAF is on Customer's account.

If Customer has failed to meet all of the Restocking rules mentioned above, SAF keeps the right to refuse the Refund, or reduce the amount of money returned.

If Customer has not requested a Restocking, Refund or raised a claim within 60 days from the date of

Invoice, the product (set) is considered to be accepted by Customer.

Shipping to SAF

If the failure is discovered to a SAF manufactured product, it will be given a Return Materials Authorization ("RMA") number and should be returned to SAF by completing the RMA form at <https://aranet.com/rma/> and then shipping the non-functioning product in its original packaging (or packaging providing a similar level of protection) to one of the facilities below.

Standard shipping address is:

SAF Tehnika
RMA Dep.
24a Ganību dambis
Rīga LV-1005
LATVIA

All North American customers should ship their products to:

SAF North America, LLC
3250 Quentin Street, Unit 128
Aurora, Colorado 80011
U.S.A.
(720) 502-0728

All returns shall be sent to SAF at the customer's expense, and shall not be considered delivered until they arrive at SAF's facilities. SAF assumes no responsibility and shall not be liable for any products damaged while in transit to SAF's facilities. SAF strongly recommends the customer to purchase an appropriate amount of insurance from the carrier they use to return the product(s) to SAF.

Inspection & Repair

Non-functioning product(s) shall be evaluated and treated as follows:

DOA. Any product discovered as non-functioning within 30 days after it is shipped to the customer, for any reason other than a customer's misuse or mishandling, shall be deemed "Dead on Arrival" or "DOA" and replaced free of charge. Aranet products will be replaced no later than 20 business days after SAF verifies its non-functioning status.

Warranty Repair. All products subject to the Warranty shall, depending on the circumstances, will be repaired or replaced free of charge within 20 business days of their arrival at SAF's facilities.

Non-warranty Repairs. SAF will repair a product for a period of 5 years after it is delivered to the customer. All products repaired outside of the Warranty shall be repaired at the customer's sole expense. A quote for repair shall be provided to the customer via e-mail prior to the product being received by SAF or within a reasonable time after the product arrives at SAF's facilities. All repair and shipping costs must be paid by the customer in advance. SAF shall repair and ship the non-functioning product within 20 business days of receiving full payment for the repairs.

Post-repair Warranty

All repaired products shall be subject to the Warranty for a period of six months after they are repaired.

The additional warranty described herein may extend but shall in no way reduce any pre-existing warranty periods already applicable to the product.

Return Costs

If a given product is covered by the Warranty, SAF will pay the shipping costs associated with returning it to the customer. If a product is outside of the Warranty, the customer shall pay all costs associated with transmitting it to and from SAF. An estimated cost of return will be included in any repair invoice sent to the customer, and must be paid before SAF will return a repaired product.

Shipping & Abandonment

Any non-functioning product remaining in SAF's possession for three months after a customer receives an invoice for repairs because the customer has failed to pay the invoice in question, shall be considered abandoned. A customer's rights in all abandoned products shall be considered forfeit and SAF shall have the right to reprocess such products in any manner it sees fit.

Sole Warranty

UNLESS SAF AGREES TO ADDITIONAL OR ALTERNATE TERMS IN WRITING, THE WARRANTY DESCRIBED HEREIN IS THE SOLE AND EXCLUSIVE WARRANTY OFFERED TO SAF'S CUSTOMERS, AND NO ADDITIONAL WARRANTIES ARE GIVEN OR IMPLIED, INCLUDING, WITHOUT LIMITATION, ANY IMPLIED WARRANTIES OF MERCHANTABILITY, NON-INFRINGEMENT, TITLE OR FITNESS FOR A PARTICULAR PURPOSE.

CHANGES TO THESE TERMS & CONDITIONS

We reserve the right to update or change our Terms and Conditions at any time and you should check these Terms and Conditions periodically. Your continued use of the Service after we post any modifications to the Terms and Conditions on this page will constitute your acknowledgment of the modifications and your consent to abide and be bound by the modified Terms and Conditions.

RMA (RETURN MERCHANDISE AUTHORIZATION) FORM

To file an RMA case, please fill out the form here: <https://aranet.com/rma/>

INTELLECTUAL PROPERTY RIGHTS

All intellectual property rights in or related to the Products including, but not limited to, patents, trade secrets, know-how, copyright, trademarks, service marks, and mask rights, registered or unregistered, owned or otherwise used by SAF, as well as all goodwill related thereto are and shall remain at all times the exclusive property of SAF. None of the foregoing property rights may be exploited by SAF's customers except as provided in these Terms nor shall such rights be transferred to SAF's customers except as expressly provided in these Terms. Each customer shall take reasonable measures to protect SAF's intellectual property rights.

SAF's and Aranet name and logo are proprietary trademarks and shall not be used without SAF's explicit

permission. The customer shall further not alter or remove any proprietary marks, logos, or labels on SAF's Products.

!NOTE Read carefully

It is responsibility of the user to enforce the country regulation and the specific environment regulation. Do not use this device if using the device is prohibited. Do not use the device if doing so causes danger or interference with other electronic devices.

Keep away from children, Do not allow children or pets to bite or suck the device or accessories. Doing so may result in damage or explosion. Observe local laws and regulations, and respect the privacy and legal rights of others.

Do not disassemble the product; any mark of tampering will compromise the warranty validity. We recommend following the instructions of this user guide for correct setup and use of the product.

DATA SECURITY

Aranet systems use encryption when the data is transmitted from the sensors to the base station. A unique encryption key is provided for each base station. The transmission protocol has built in safeguards against malicious operations (for example replay attacks).

Aranet sensors are protected from unauthorized data collection, therefore even if sensors are accessed the software used and the configuration parameters cannot be compromised.

To connect new sensors the user needs to be in proximity to the base station, therefore it is not possible to connect new sensors without authorization in order to compromise Aranet system by obtaining the encryption key.

CLEANING AND MAINTENANCE

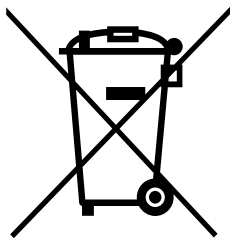

Keep the device and accessories dry. Do not attempt to dry it with an external heat source, such as microwave oven or hair dryer.

Do not expose your device and accessories to extreme cold or heat. These environments may interfere with proper function and may lead to fire or explosion.

Avoid collision, which may lead to device malfunctions, overheating, fire, or explosion.



Please handle the product with care, avoiding any dropping and contact with the internal circuit board as electrostatic discharges may damage the product itself.

CAUTION: ARANET PRO BASE STATION CONTAIN AN ENCLOSED BATTERY. RISK OF DAMAGE IF BATTERY IS REPLACED BY AN INCORRECT TYPE. DISPOSE OF USED BATTERIES ACCORDING TO THE INSTRUCTIONS. The user is responsible for disposal of the batteries according to the WEEE Directive Recast (Directive 2012/19/EU) and Battery Directive (Directive 2006/66/EC). Batteries should not be disposed of as household garbage. These items should not be disposed as of unsorted municipal waste and should be taken to a certified collection point for recycling or proper disposal.

ACCESSORIES

Use only power supplies which are provided by manufacturer and in the original packaging of this product.

Using unapproved or incompatible power adapter, charger or battery may cause fire, explosion or other hazards.

Choose only accessories approved for use with this model by the device manufacturer. The use of any other types of accessories may void the warranty, may violate local regulations and laws and may be dangerous, Please contact your retailer for information about the availability of approved accessories in your area.

DISCLAIMER

All contents of this manual are provided "as is". Except as required by applicable laws, no warranties of any kind, either express or implied, including but not limited to, the implied warranties of merchantability and fitness for a particular purpose, are made in relation to the accuracy, reliability or contents of this manual.

To the maximum extent permitted by applicable law, in no event shall SAF Tehnika JSC be liable for any special, incidental, indirect, or consequential damages, or loss of profits, business, revenue, data, goodwill savings or anticipated savings regardless of whether such losses are foreseeable or not.

ADDITIONAL INFORMATION

For additional information, please contact helpdesk@aranet.com



SAF Tehnika JSC
24a, Ganību Dambis
Rīga, LV-1005, Latvia